

Digital HD Video Camera Recorder

Operating Guide

Before operating the unit, please read this manual thoroughly, and retain it for future reference

The supplied CD-ROM includes Operating Guide for the HVR-HD1000 series. (English, French, German, Italian, Spanish, and Simplified Chinese versions). For more details, see "Using the CD-ROM Manual" on page 11.

Le CD-ROM fourni contient le mode d'emploi de la série HVR-HD1000 (en anglais, français, allemand, italien, espagnol et chinois simplifié). Pour de plus amples renseignements, consultez la section « Using the CD-ROM Manual » à la page 11.

HDV
HDV 1080i

Mini DV Digital
Video
Cassette

MEMORY STICK™

 InfoLITHIUM™
SERIES

HDMI

HVR-HD1000U/HD1000N

IMPORTANT SAFEGUARDS

Owner's Record

The model and serial numbers are located on the bottom. Record the serial number in the space provided below. Refer to these numbers whenever you call your Sony dealer regarding this product.

Model No. HVR-HD1000U/HD1000N

Serial No.

Model No. AC-

Serial No.

WARNING

To reduce fire or shock hazard, do not expose the unit to rain or moisture.

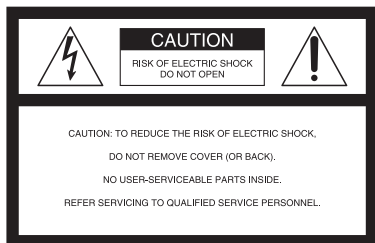

This symbol is intended to alert the user to the presence of uninsulated “dangerous voltage” within the product’s enclosure that may be of sufficient magnitude to constitute a risk of electric shock to persons.



This symbol is intended to alert the user to the presence of important operating and maintenance (servicing) instructions in the literature accompanying the appliance.

For your protection, please read these safety instructions completely before operating the appliance, and keep this manual for future reference.

Carefully observe all warnings, precautions and instructions on the appliance, or the one described in the operating instructions and adhere to them.

Use

Power Sources

This set should be operated only from the type of power source indicated on the marking label. If you are not sure of the type of electrical power supplied to your home, consult your dealer or local power company. For those sets designed to operate from battery power, or other sources, refer to the operating instructions.

Polarization

This set may be equipped with a polarized ac power cord plug (a plug having one blade wider than the other).

This plug will fit into the power outlet only one way. This is a safety feature. If you are unable to insert the plug fully into the outlet, try reversing the plug. If the plug should still fail to fit, contact your electrician to have a suitable outlet installed. Do not defeat the safety purpose of the polarized plug by forcing it in.

Overloading

Do not overload wall outlets, extension cords or convenience receptacles beyond their capacity, since this can result in fire or electric shock.

Object and Liquid Entry

Never push objects of any kind into the set through openings as they may touch dangerous voltage points or short out parts that could result in a fire or electric shock. Never spill liquid of any kind on the set.

Attachments

Do not use attachments not recommended by the manufacturer, as they may cause hazards.

Cleaning

Unplug the set from the wall outlet before cleaning or polishing it. Do not use liquid cleaners or aerosol cleaners. Use a cloth lightly dampened with water for cleaning the exterior of the set.

Installation

Water and Moisture

Do not use power-line operated sets near water – for example, near a bathtub, washbowl, kitchen sink, or laundry tub, in a wet basement, or near a swimming pool, etc.

Power-Cord Protection

Route the power cord so that it is not likely to be walked on or pinched by items placed upon or against them, paying particular attention to the plugs, receptacles, and the point where the cord exits from the appliance.

Accessories

Do not place the set on an unstable cart, stand, tripod, bracket, or table. The set may fall, causing serious injury to a child or an adult, and serious damage to the set. Use only a cart, stand, tripod, bracket, or table recommended by the manufacturer.

Ventilation

The slots and openings in the cabinet are provided for necessary ventilation. To ensure reliable operation of the set, and to protect it from overheating, these slots and openings must never be blocked or covered.

- Never cover the slots and openings with a cloth or other materials.
- Never block the slots and openings by placing the set on a bed, sofa, rug, or other similar surface.
- Never place the set in a confined space, such as a bookcase, or built-in cabinet, unless proper ventilation is provided.
- Do not place the set near or over a radiator or heat register, or where it is exposed to direct sunlight.

Lightning

For added protection for this set during a lightning storm, or when it is left unattended and unused for long periods of time, unplug it from the wall

outlet and disconnect the antenna or cable system. This will prevent damage to the set due to lightning and power-line surges.

Service

Damage Requiring Service

Unplug the set from the wall outlet and refer servicing to qualified service personnel under the following conditions:

- When the power cord or plug is damaged or frayed.
- If liquid has been spilled or objects have fallen into the set.
- If the set has been exposed to rain or water.
- If the set has been subject to excessive shock by being dropped, or the cabinet has been damaged.
- If the set does not operate normally when following the operating instructions. Adjust only those controls that are specified in the operating instructions. Improper adjustment of other controls may result in damage and will often require extensive work by a qualified technician to restore the set to normal operation.
- When the set exhibits a distinct change in performance – this indicates a need for service.

Servicing

Do not attempt to service the set yourself as opening or removing covers may expose you to dangerous voltage or other hazards.

Refer all servicing to qualified service personnel.

Replacement parts

When replacement parts are required, be sure the service technician has used replacement parts specified by the manufacturer that have the same characteristics as the original parts.

Unauthorized substitutions may result in fire, electric shock, or other hazards.

Safety Check

Upon completion of any service or repairs to the set, ask the service technician to perform routine safety checks (as specified by the manufacturer) to determine that the set is in safe operating condition.

Read this first

Before operating the unit, please read this manual thoroughly, and retain it for future reference.

CAUTION

Replace the battery with the specified type only. Otherwise, fire or injury may result.

Excessive sound pressure from earphones and headphones can cause hearing loss.

Do not expose the batteries to excessive heat such as sunshine, fire or the like.

For customers in the U.S.A. and CANADA

RECYCLING LITHIUM-ION BATTERIES

Lithium-Ion batteries are recyclable.

You can help preserve our environment by returning your used rechargeable batteries to the collection and recycling location nearest you.

For more information regarding recycling of rechargeable batteries, call toll free 1-800-822- 8837, or visit <http://www.rbrcc.org/>

Caution: Do not handle damaged or leaking Lithium-Ion batteries.

For customers in the U.S.A.

If you have any questions about this product, you may call:

Sony Customer Information Center 1-800-686 SONY (7669).

The number below is for the FCC related matters only.



Regulatory Information

Declaration of Conformity

Trade Name: SONY

Model No.: HVR-HD1000U

Responsible Party: Sony Electronics Inc.

Address: 16530 Via Esprillo, San Diego, CA 92127 U.S.A

Telephone number: 858-942-2230

This device complies with Part 15 of the FCC Rules.

Operation is subject to the following two conditions:

(1) This device may not cause harmful interference, and (2) this device must accept any interference received, including interference that may cause undesired operation.

CAUTION

You are cautioned that any changes or modifications not expressly approved in this manual could void your authority to operate this equipment.

Notes

This equipment has been tested and found to comply with the limits for a Class B digital device, pursuant to Part 15 of the FCC Rules.

These limits are designed to provide reasonable protection against harmful interference in a residential installation. This equipment generates, uses, and can radiate radio frequency energy and, if not installed and used in accordance with the instructions, may cause harmful interference to radio communications.

However, there is no guarantee that interference will not occur in a particular installation. If this equipment does cause harmful interference to radio or television reception, which can be determined by turning the equipment off and on, the user is encouraged to try to correct the interference by one or more of the following measures:

- Reorient or relocate the receiving antenna.
- Increase the separation between the equipment and receiver.
- Connect the equipment into an outlet on a circuit different from that to which the receiver is connected.
- Consult the dealer or an experienced radio/TV technician for help.

The supplied interface cable must be used with the equipment in order to comply with the limits for a digital device pursuant to Subpart B of Part 15 of FCC Rules.

Français

AVERTISSEMENT

Pour réduire les risques d'incendie ou d'électrocution, tenir cet appareil à l'abri de la pluie et de l'humidité.

Une pression sonore excessive des écouteurs ou du casque peut provoquer des pertes d'audition.

N'exposez pas les piles à une chaleur excessive comme à la lumière du soleil, au feu ou à d'autres sources de chaleur.

ATTENTION

Remplacez la batterie par une batterie du type spécifié uniquement. Sinon vous risquez de provoquer un incendie ou des blessures.

- N'utilisez pas l'adaptateur CA dans un espace étroit (entre un mur et un meuble par exemple).

Pour la clientèle au Canada

RECYCLAGE DES ACCUMULATEURS AUX IONS DE LITHIUM

Les accumulateurs aux ions de lithium sont recyclables. Vous pouvez contribuer à préserver l'environnement en rapportant les piles usées dans un point de collection et recyclage le plus proche



Pour plus d'informations sur le recyclage des accumulateurs, téléphonez le numéro gratuit 1-800-822-8837 (Etats-Unis et Canada uniquement), ou visitez <http://www.rbrc.org/>

Avertissement : Ne pas utiliser des accumulateurs aux ions de lithium qui sont endommagés ou qui fuient.

Notes on use

Type of cassette you can use in your camcorder

You can use mini DV cassettes marked with ^{Mini} **DV**. Your camcorder is not compatible with the Cassette Memory function (p. 89).

The HDV standards

- Digital high-definition (HD) video signals are recorded and played back on a DV format cassette.
- HDV signals are compressed in MPEG2 format, which is adopted in BS (broadcast satellite) digital and terrestrial digital HDTV broadcastings and in Blu-ray disc recorders.

Types of “Memory Stick” you can use in your camcorder

You can use “Memory Stick” marked with the following (p. 90).

- MEMORY STICK DUO (“Memory Stick Duo”)
- MEMORY STICK PRO DUO (“Memory Stick PRO Duo”)
- MEMORY STICK PRO-HG DUO (“Memory Stick PRO-HG Duo”).

“Memory Stick Duo”
(This size can be used with your camcorder.)



“Memory Stick”
(You cannot use with your camcorder.)



- You cannot use any type of memory card except “Memory Stick Duo.”

- “Memory Stick PRO Duo” can be used only with “Memory Stick PRO” compatible equipment.
- Do not attach a label or the like on a “Memory Stick Duo” or a Memory Stick Duo adaptor.

When using a “Memory Stick Duo” with “Memory Stick” compatible equipment

Be sure to insert the “Memory Stick Duo” into the Memory Stick Duo Adaptor.

Memory Stick Duo Adaptor



Using the camcorder

- Do not hold the camcorder by the following parts.

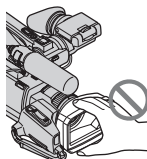

Lens hood

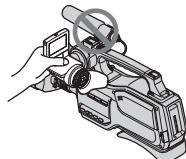

panel EVF block

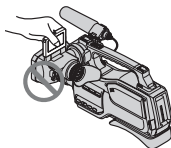

LCD panel

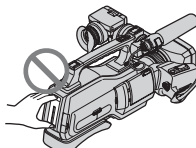

Battery pack

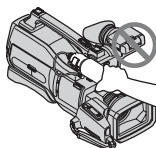

Microphone

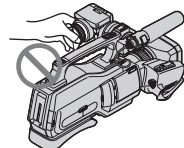

Viewfinder

- The camcorder is not dustproof, dripproof or waterproof.
See “On using your camcorder” (p. 94).
- When connecting your camcorder to another device with communication cables, be sure to insert the connector plug in the correct way. Pushing the plug forcibly into the terminal will damage the terminal and may result in a malfunction of your camcorder.

About menu items, LCD panel, viewfinder, and lens

- A menu item that is grayed out is not available under the current recording or playback conditions.
- The LCD screen and the viewfinder are manufactured using extremely high-precision technology, so over 99.99% of the pixels are operational for effective use. However, there may be some tiny black points and/or bright points (white, red, blue, or green in color) that appear constantly on the LCD screen and the viewfinder. These points are normal results of the manufacturing process and do not affect the recording in any way.

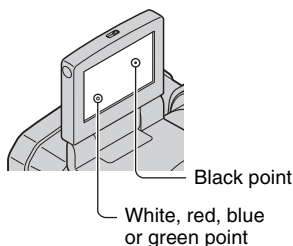

- Exposing the LCD screen, the viewfinder, or the lens to direct sunlight for long periods of time may cause malfunctions.
- Do not aim at the sun. Doing so might cause your camcorder to malfunction. Take pictures of the sun only in low light conditions, such as at dusk.

About changing the language setting

The on-screen displays in each local language are used for illustrating the operating procedures. Change the screen language before using your camcorder if necessary (p. 18).

On recording

- Before starting to record, test the recording function to make sure the picture and sound are recorded without any problems.
- Compensation for the contents of recordings cannot be provided, even if recording or playback is not possible due to a malfunction of the camcorder, storage media, etc.
- TV color systems differ depending on the country/region. To view your recordings on a TV, you need an NTSC system-based TV.
- Television programs, films, video tapes, and other materials may be copyrighted. Unauthorized recording of such materials may be contrary to the copyright laws.

On playing back HDV tapes on other devices

You cannot play back a tape recorded in the HDV format on DV format video cameras or on mini DV players (The screen appears blue).

Check the contents of tapes by playing them back on this camcorder prior to playing them back on other devices.

Notes on the icons used in this manual

HDV1080i Features available for the HDV format only.

DV Features available for the DV format only.

About this manual

- The images of the LCD screen and the viewfinder used in this manual for

Read this first (Continued)

illustration purposes are captured using a digital still camera, and therefore may appear different.

- Design and specifications of recording media and other accessories are subject to change without notice.

About the Carl Zeiss lens

Your camcorder is equipped with a Carl Zeiss lens, which was developed jointly by Carl Zeiss, in Germany, and Sony Corporation, and produces superior images. It adopts the MTF measurement system for video cameras and offers a quality typical of a Carl Zeiss lens. Also, the lens for your camcorder is T*^{*}-coated to suppress unwanted reflections and faithfully reproduce colors.

MTF= Modulation Transfer Function

The number value indicates the amount of light from a subject coming into the lens.

Table of Contents

IMPORTANT SAFEGUARDS	2
Read this first	4
Notes on use	6
Using the CD-ROM Manual	11

Getting Started

Step 1: Checking supplied items	12
Step 2: Attaching the supplied microphone, eyecup and the lens hood	13
Step 3: Charging the battery pack	15
Step 4: Turning the power on and setting the date and time	18
Changing the language setting	18
Step 5: Making setting adjustments before recording	19
Step 6: Inserting a tape or a "Memory Stick Duo"	20



Recording/Playback

Recording	22
Zooming	24
Recording high quality still images during tape recording (Dual Rec)	24
Controlling the image settings manually with the RING	25
Recording in dark places (NightShot)	25
Adjusting the exposure for backlit subjects	26
Recording in mirror mode	26
Playback	27
Using PB zoom	29
Searching for the starting point	30
Searching for the last scene of the most recent recording (END SEARCH)	30

Reviewing the most recently recorded scenes (Rec review)	30
Playing the picture on a TV	31
Connecting to a high definition TV	32
Connecting to a 16:9 (wide) or 4:3 TV	33

Using the Menu

Using the menu items	36
Menu items	37
CAMERA SET menu	39
Settings to adjust your camcorder to the recording conditions	
MEMORY SET menu	46
Settings for the "Memory Stick Duo"	
PICT.APPLI. menu	49
Special effects on pictures or additional functions on recording/ playback	
EDIT/PLAY menu	52
Settings for editing or playing back in various modes	
STANDARD SET menu	53
Settings while recording on a tape or other basic settings	
TIME/LANGU. menu	59
Customizing Personal Menu	60

Dubbing/Editing

Dubbing to VCR or DVD/HDD recorders	62
Recording pictures from a VCR	65
Dubbing pictures from a tape to a "Memory Stick Duo"	67
Deleting recorded pictures from the "Memory Stick Duo"	67
Marking images on the "Memory Stick Duo" with specific information (Print mark/Image protection)	68

Printing recorded images (PictBridge compliant printer)	69
---	----

Using a Computer

Connecting to a computer	71
Copying still images to a computer	71
Copying movies on a tape to a computer	74

Troubleshooting

Troubleshooting	77
Warning indicators and messages	85
Self-diagnosis display/Warning indicators	85

Additional Information

Using your camcorder abroad	88
Maintenance and precautions	89
Usable cassette tapes	89
About the "Memory Stick"	90
About the "InfoLITHIUM" battery pack	92
About i.LINK	93
About x.v.Color	94
On using your camcorder	94
Specifications	98

Quick Reference

Identifying parts and controls	101
Indicators displayed during recording/playback	104
Index	108

Using the CD-ROM Manual

English

The supplied CD-ROM includes versions of the Operating Guide for the HVR-HD1000U/HD1000N series in English, French, German, Italian, Spanish, and Simplified Chinese in PDF format.

Preparation

The following program must be installed on your computer in order to read the Operating Guide contained on the CD-ROM.

- Adobe Reader Version 7.0 or higher

Tips

- If Adobe Reader is not installed, you can download it from the following URL: <http://www.adobe.com/>

Adobe and Adobe Reader are trademarks of Adobe Systems Incorporated in the United States and/or other countries.

Reading the CD-ROM Manual

To read the Operating Guide contained on the CD-ROM, do the following.

1 Insert the CD-ROM in your CD-ROM drive.

A cover page appears automatically in your browser.

If it does not appear automatically in the browser, double-click on the index.htm file on the CD-ROM.

2 Select and click on the Operating Guide that you want to read.

This opens the PDF file of the Operating Guide.

Tips

- The files may not be displayed properly, depending on the version of Acrobat Reader. In such a case, install the latest version you can download from the URL mentioned in "Preparation" above.

français

Le CD-ROM fourni contient le mode d'emploi de la série HVR-HD1000U/HD1000N en format PDF en anglais, français, allemand, italien, espagnol et chinois simplifié.

Préparation

Le logiciel suivant doit être installé sur votre ordinateur afin d'être en mesure de lire le mode d'emploi qui se trouve sur le CD-ROM.

- Adobe Reader version 7.0 ou ultérieure

Conseils

- Si le logiciel Adobe Reader n'est pas installé, vous pouvez le télécharger à partir de l'adresse URL suivante : <http://www.adobe.com/>
Adobe et Adobe Reader sont des marques de commerce de Adobe Systems Incorporated aux États-Unis et/ou dans d'autres pays.

Lecture du manuel du CD-ROM

Pour lire le mode d'emploi qui se trouve sur le CD-ROM, procédez comme suit :

1 Insérez le CD-ROM dans votre lecteur de CD-ROM.

Une page de garde apparaît automatiquement dans votre navigateur. Si cette page n'apparaît pas automatiquement, double-cliquez sur le fichier index.htm sur le CD-ROM.

2 Cliquez sur la version du mode d'emploi que vous désirez lire.

Le fichier PDF du mode d'emploi s'ouvrira alors.

Conseils

- Selon votre version de Adobe Reader, il se peut que les fichiers ne s'affichent pas correctement. En pareil cas, installez la plus récente version à partir de l'adresse URL indiquée dans la section « Préparation » ci-dessus.

Step 1: Checking supplied items

Make sure that you have following items supplied with your camcorder. The number in the parentheses indicates the number of that item supplied.

AC Adaptor (1) (p. 15)

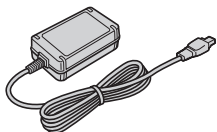

Power cord (mains lead) (1) (p. 15)



A/V connecting cable (1) (p. 31, 62)



Eye cup (1)

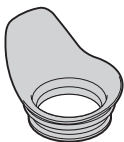

Rechargeable battery pack NP-F570 (1)
(p. 15, 92)

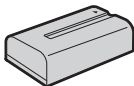

Lens hood (1)

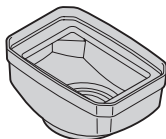

Lens cap (1)

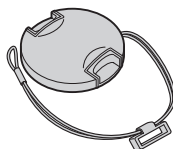

Wind screen (1) (p. 13)
Microphone (1) (p. 13)

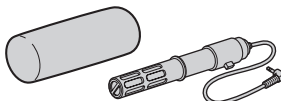

CD-ROM
"Manuals for Digital HD Video Camera Recorder"(1)

Operating Guide (This manual) (1)

To attach the lens cap to the grip belt

Remove the grip belt and attach the lens cap by leading the grip belt through the attachment on the lens cap string. Then attach the grip belt to the camcorder again.

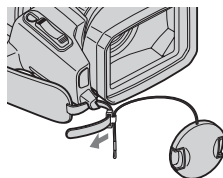

Step 2: Attaching the supplied microphone, eyecup and the lens hood

Attaching the supplied microphone

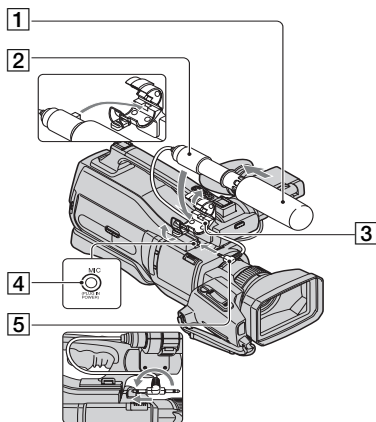

1 Attach the wind screen **1** to the microphone **2**.

2 Unlock the stopper of the microphone holder **3** and open the cover.

3 Align the convex part of the microphone with the concave part of the holder, then place the microphone into the holder. Close the cover and lock the stopper securely.
Be sure to align the ▲ mark on the microphone and the | mark on the holder facing each other.

4 Turn the plug of the microphone counter-clockwise to 180 degrees in the direction of the arrow **5**, and connect it to the Mic jack **4**.

Attaching the eyecup

Attach the eyecup aligned with the eyecup groove in the viewfinder. You can attach the eyecup facing either the right or left side.

Attach the eyecup securely until it fits the corresponding part properly.

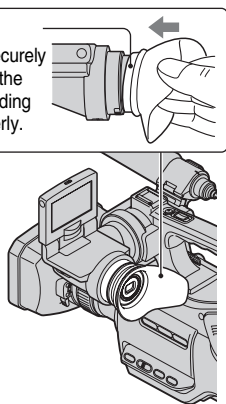

Step 2: Attaching the supplied microphone and the lens hood (Continued)

Attaching the lens hood

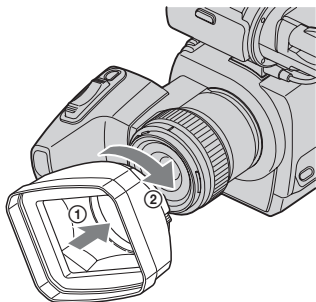

Align the marks on the lens hood to those on the camcorder, and turn the lens hood in the direction of the arrow.

To remove the Lens hood

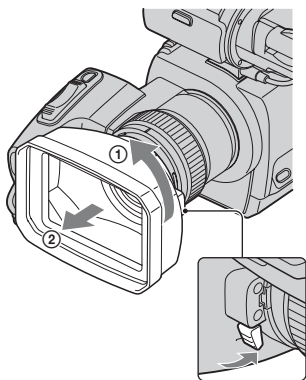

Turn the lens hood cover in the opposite direction of the arrow as illustrated above while pressing the lever on the lens hood cover.

Tips

- If you attach, remove or adjust an 37mm (2 1/2in.) PL filter or MC protector, remove the lens hood.

Attaching the lens cap

Attach the lens cap by pressing both knobs on its sides.

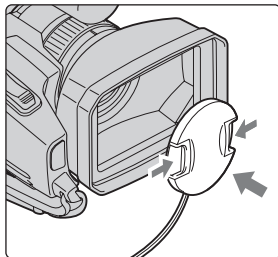

Step 3: Charging the battery pack

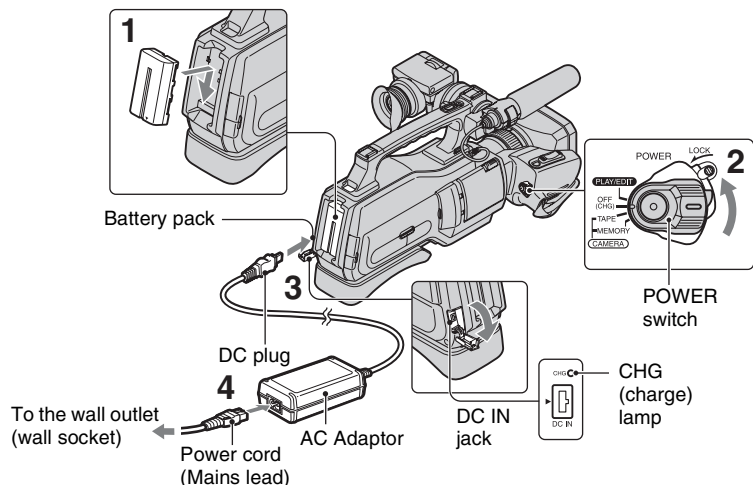

You can charge the “InfoLITHIUM” battery pack (L series) (p. 92) after attaching it to your camcorder.

Notes

- You cannot attach any “InfoLITHIUM” battery pack other than the L series to your camcorder.

1 Attach the battery pack to your camcorder.

Attach the battery pack by sliding it in the direction of the arrow while pressing it until it clicks.

2 Slide the POWER switch to OFF (CHG).

3 Connect the AC Adaptor to the DC IN jack of your camcorder. Be sure that the ▲ mark on the DC

plug is facing to the ▲ mark on your camcorder.

4 Connect the power cord (mains lead) to the AC Adaptor and the wall outlet (wall socket).

The CHG (charge) lamp lights up and charging starts. The CHG (charge) lamp turns off when the battery is fully charged.

Notes

- Disconnect the AC Adaptor from the DC IN jack holding both the camcorder and the DC plug.

Tips

- You can operate your camcorder connected to a power source such as a wall outlet (wall socket) as shown in the illustration. The battery pack will not lose its charge in this case.

Step 3: Charging the battery pack (Continued)

To remove the battery pack

Slide the POWER switch to OFF (CHG).
Push the [BATT (battery) RELEASE] button and remove the battery pack.

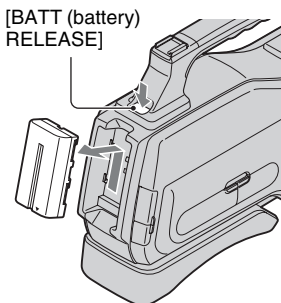

When storing the battery pack

Fully discharge the battery before storing it for an extended period (p. 92).

To check the remaining battery (Battery Info)

Set the POWER switch to OFF (CHG), then press DISPLAY/BATT INFO.

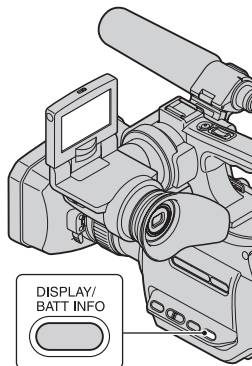

After a while, the approximate recordable time and battery information appear for about 7 seconds. You can view the battery

information for up to 20 seconds by pressing DISPLAY/BATT INFO again while the information is displayed.

Remaining battery (approx.)

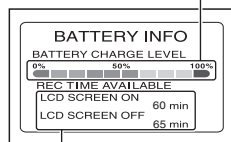

Recording capacity (approx.)

You can check the remaining battery charge on the LCD screen.

Indicator	Status
	Sufficient power remaining
	Battery low, recording/playback will stop soon.
	Replace the battery with a fully charged one, or charge the battery.

Charging time

Approximate time (min.) required when you fully charge a fully discharged battery pack.

Battery pack	Charging time
NP-F570 (supplied)	260
NP-F770	450
NP-F970	630

Recording time

Approximate time (min.) available when you use a fully charged battery pack.

Battery pack	Continuous recording time		Typical recording time*	
	HDV	DV	HDV	DV
Recording Format				
NP-F570 (supplied)	180	190	95	105
	200	205	105	115

Battery pack	Continuous recording time		Typical recording time*	
	HDV	DV	HDV	DV
Recording Format				
NP-F770	375	390	200	220
	410	425	220	240
NP-F970	555	580	295	330
	605	630	325	355

* Typical recording time shows the time when you repeat recording start/stop, turning the power on/off and zooming.

Notes

- All times measured under the following conditions:
Top: When the LCD turns on.
Bottom: Recording with the viewfinder while the LCD turns off.
- You cannot turn off the viewfinder.

Playing time

Approximate time (min.) available when you use a fully charged battery pack.

Battery pack	LCD panel on		LCD panel off	
	HDV	DV	HDV	DV
Recorded Format				
NP-F570 (supplied)	260	280	295	315
	540	570	605	650
NP-F770	780	830	890	950

On the battery pack

- Before changing the battery pack, slide the POWER switch to OFF (CHG).
- The CHG (charge) lamp flashes during charging, or Battery Info (p. 16) will not be correctly displayed under the following conditions.
 - The battery pack is not attached correctly.
 - The battery pack is damaged.
 - The battery pack is worn-out (for Battery Info only).
- The power will not be supplied from the battery as long as the AC Adaptor is connected to the

DC IN jack of your camcorder, even when the power cord (mains lead) is disconnected from the wall outlet (wall socket).

On the charging/recording/playback time

- Times measured with the camcorder at 25 °C (77 °F) (10 to 30 °C (50 °F to 86 °F) is recommended).
- The recording and playback time will be shorter when you use your camcorder in low temperatures.
- The recording and playback time will be shorter depending on the conditions under which you use your camcorder.

On the AC Adaptor

- Use the nearby wall outlet when using the AC Adaptor. Disconnect the AC Adaptor from the wall outlet immediately if any malfunction occurs while using your camcorder.
- Do not use the AC Adaptor placed in a narrow space, such as between a wall and furniture.
- Do not short-circuit the DC plug of the AC Adaptor or battery terminal with any metallic objects. This may cause a malfunction.
- Even if your camcorder is turned off, AC power (house current) is still supplied to it while connected to the wall outlet via the AC Adaptor.

Step 4: Turning the power on and setting the date and time

Set the date and time when using this camcorder for the first time. If you do not set the date and time, the [CLOCK SET] screen appears every time you turn on your camcorder or change the POWER switch position.

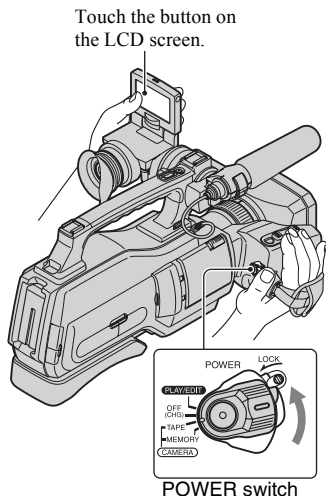

Touch the button on the LCD screen.

POWER switch

- 1 Slide the **POWER** switch to **TAPE** or **MEMORY** while pressing the green button.

TAPE: To record on a tape.

MEMORY: To record on a "Memory Stick Duo."

PLAY/EDIT: To play or edit pictures.

The [CLOCK SET] screen appears.

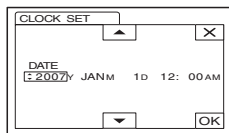

- 2 Set [Y] (year) with \uparrow/\downarrow , then touch **OK**.

You can set any year up to the year 2079.

- 3 Set [M] (month), then touch **OK** and repeat for [D] (day), hour and minute.

For midnight, set it to 12:00 AM.

For midday, set it to 12:00 PM.

The clock starts.

To turn off the power

Slide the **POWER** switch to **OFF (CHG)**.

To reset the date and time

You can set the desired date and time by touching **[P-MENU]** → **[MENU]** → **(TIME/LANGU.)** → **[CLOCK SET]** (p. 36).

Notes

- If you do not use your camcorder for **about 3 months**, the built-in rechargeable battery gets discharged and the date and time settings may be cleared from the memory. In that case, charge the rechargeable battery and then set the date and time again (p. 97).

Tips

- The date and time are not displayed while recording, but they are automatically recorded on the tape, and can be displayed during playback (see page 58 for [DATA CODE]).
- If the buttons on the touch panel do not work correctly, adjust the touch panel (CALIBRATION) (p. 96).

Changing the language setting

You can change the on-screen displays to show messages in a specified language.

Touch **[P-MENU]** → **[MENU]** → **(TIME/LANGU.)** → **[LANGUAGE]**, then select the desired language.

Step 5: Making setting adjustments before recording

The LCD panel

Open the LCD panel (①), then rotate it to the best angle to record or play (②).

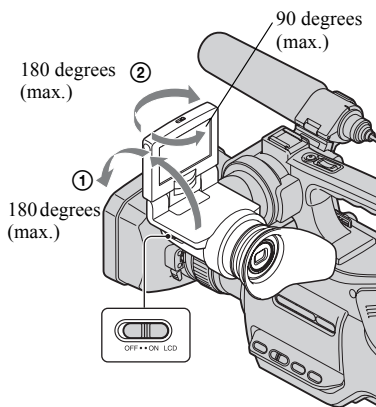

To turn off the LCD screen

Set the LCD ON/OFF switch to OFF. This helps to make the battery last longer. The recorded picture will not be affected by the setting. To turn on the LCD screen, set the LCD ON/OFF switch to ON.

Notes

- When the LCD ON/OFF switch is set to OFF, you cannot operate the touch panel.

Tips

- If you rotate the LCD panel 180 degrees to the lens side, you can close the LCD panel with the LCD screen facing out. This is convenient during playback operations.
- See [LCD/VF SET] - [LCD BRIGHT] (p. 55) to adjust the brightness of the LCD screen.
- Press DISPLAY/BATT INFO to toggle the screen indicators (such as Battery Info) on or off.

The viewfinder

Pull out the LCD panel block to adjust the position (①), and rotate the viewfinder to the best angle (②).

You can view pictures using the viewfinder to avoid wearing down the battery, or when the picture seen on the LCD screen is poor.

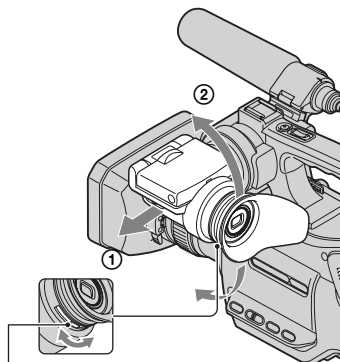

Viewfinder lens adjustment lever
Move it until the picture is clear.

Tips

- You can adjust the brightness of the viewfinder backlight by selecting [LCD/VF SET] - [VF B.LIGHT] (p. 55).

The shoulder pad

You can adjust the position of the shoulder pad by loosen the screws illustrated below. Tighten the screws again after adjustment.

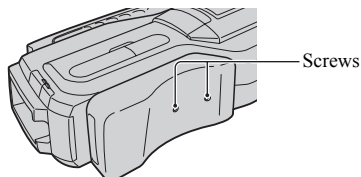



Step 6: Inserting a tape or a “Memory Stick Duo”

Cassette tape

You can use mini DV **Mini DV** cassettes only (p. 89).

Notes

- The recordable time varies depending on [ REC MODE] (p. 54). **DV**

- 1** Slide and hold the  **OPEN/EJECT** lever in the direction of the arrow and open the lid.

 **OPEN/EJECT** lever

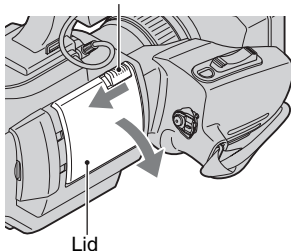

The cassette compartment automatically comes out and opens up.

- 2** Insert a cassette with its window facing outwards, then press .

Push the center of the back of the cassette lightly.

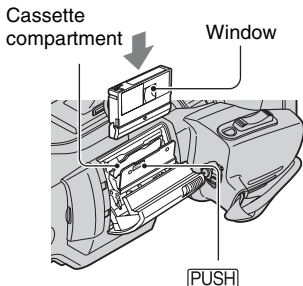

The cassette compartment automatically slides back in.

- 3** Close the lid.

To eject the cassette

Open the lid following the same procedure as described in step 1 and remove the cassette.

Notes

- Do not force the cassette compartment closed by pressing the portion marked  while it is sliding in. It may cause a malfunction.

“Memory Stick Duo”

You can use only a “Memory Stick Duo” marked with **MEMORY STICK DUO** or **MEMORY STICK PRO DUO** (p. 90).

Tips

- The number and time of recordable pictures vary depending on the image quality or the image size. For details, see page 46.

1 Open the jack cover.

2 Insert the “Memory Stick Duo” into the “Memory Stick Duo” slot in the right direction until it clicks.

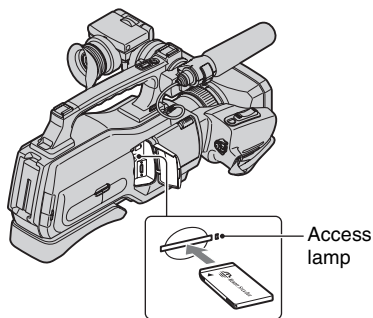

To eject a “Memory Stick Duo”

Lightly push the “Memory Stick Duo” in once.

Notes

- When the access lamp is lit or flashing, your camcorder is reading/writing data. Do not shake or knock your camcorder, turn the power off, eject the “Memory Stick Duo,” or remove the battery pack. Otherwise, image data may be damaged.
- If you force the “Memory Stick Duo” into the slot in the wrong direction, the “Memory Stick Duo,” the “Memory Stick Duo” slot, or image data may be damaged.
- When inserting or ejecting the “Memory Stick Duo,” be careful that the “Memory Stick Duo” does not pop out and drop.

Recording

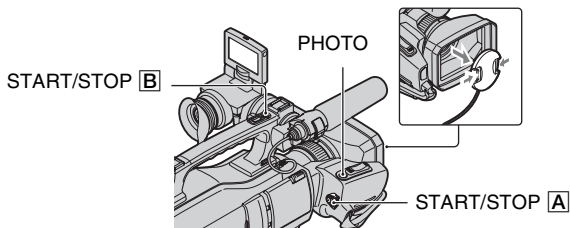

Recording movies



Movies are recorded on a tape.

- 1 Remove the lens cap by pressing both knobs on its sides.
- 2 Slide the **POWER** switch to **TAPE** while pressing the green button.

Note on the LOCK switch

When you slide the LOCK switch to the lock position (the POWER switch side), the POWER switch can no longer be set to MEMORY accidentally. (The LOCK switch is set to the unlock position at the time of purchase.)

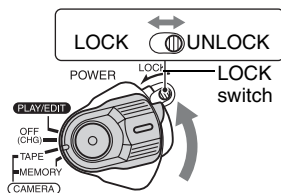

- 3 Press **START/STOP** **A** (or **B**).

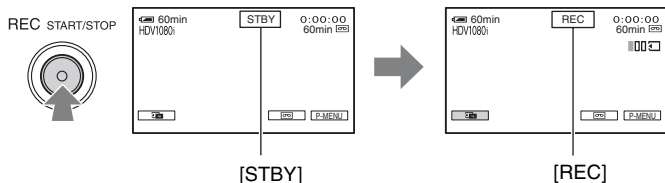

To stop recording, press **START/STOP** again.

💡 Tips

- The pictures are recorded in the HDV format in the default setting (p. 54).

To record high quality still images during tape recording (Dual Rec)

See page 24 for details.

Recording still images

Still images are recorded on the “Memory Stick Duo.”

- 1 Remove the lens cap by pressing both knobs on its sides.
- 2 Slide the POWER switch to MEMORY while pressing the green button.

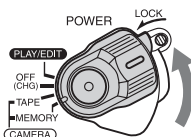

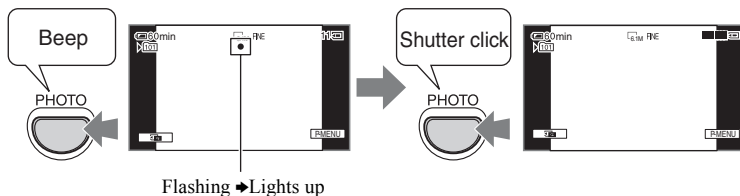

- 3 Press and hold PHOTO lightly to adjust the focus, then press it fully to record.



A shutter sound is heard. When  disappears, the image has been recorded.

To check the latest recording on a “Memory Stick Duo”

Touch . To delete the picture, touch  → [YES].

Tips

- See page 46 for the image quality, image size and the number of recordable pictures.

Recording (Continued)

Zooming

You can magnify images to 10 times the original size with the power zoom lever.

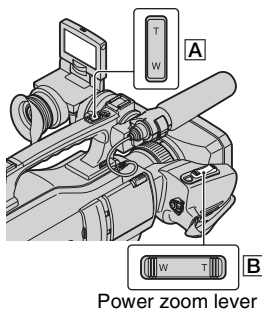

Power zoom lever

Close view: (Telephoto)

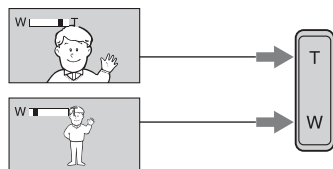

Wider range of view: (Wide angle)

Move the power zoom lever **B** slightly for a slower zoom. Move it further for a faster zoom.

Notes

- Be sure to keep your finger on the power zoom lever. If you move your finger off the power zoom lever, the operation sound of the power zoom lever may also be recorded.
- You can not change the zoom speed of the zoom lever **A** on the handle.
- The minimum possible distance between camcorder and subject while maintaining sharp focus is about 1 cm (about 13/32 in.) for wide angle and about 80 cm (about 2 5/8 feet) for telephoto.

Tips

- You can set [DIGITAL ZOOM] (p. 44) if you want to zoom to a level greater than 10 ×.

- You can also adjust the setting manually using the RING (p. 25)

Recording high quality still images during tape recording (Dual Rec)

You can record high quality still images on the “Memory Stick Duo” during tape recording.

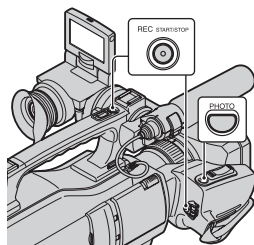

- ① Slide the POWER switch to TAPE, then press START/STOP to start tape recording.
- ② Press PHOTO fully.

For each separate time tape recording, up to 3 still images can be recorded.



Orange color boxes indicate the number of recorded images. When recording is finished, the color changes to orange.

- ③ Press START/STOP to stop tape recording. Stored still images appear one by one, and the images are stored onto the “Memory Stick Duo.” When  disappears, the image has been recorded.

Notes

- Do not eject the “Memory Stick Duo” before tape recording is finished and the still images are stored on the “Memory Stick Duo.”

💡 Tips

- During the standby mode, still images will be stored in the same way as when the POWER switch is set to MEMORY.
- When the POWER switch is set to TAPE, still images will be recorded at image size 4.6M in the HDV format, 3.4M (4:3) or 4.6M (16:9) in the DV format.

Controlling the image settings manually with the RING

It is useful to assign a frequently used menu item to the RING.

The following is an example of the procedure when the [FOCUS] setting is assigned (the default setting).

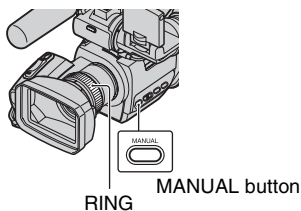

- ① Press the MANUAL button to activate the manual adjustment mode.
The setting mode switches between automatic and manual every time you press the MANUAL button.
- ② Rotate the RING to adjust the focus manually.

Menu items that can be assigned

- [FOCUS] (p. 42)
- [ZOOM] (p. 24)
- [EXPOSURE] (p. 40)
- [SHUTTR SPEED] (p. 41)
- [AE SHIFT] (p. 41)
- [WB SHIFT] (p. 42)

To assign the menu items to the RING

- ① Press and hold the MANUAL button for several seconds.
The [RING SETTING] screen appears.

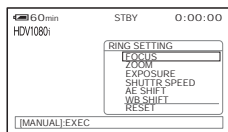

- ② Rotate the RING and select a menu item to be assigned.
- ③ Press the MANUAL button.

🔗 Notes

- The menu item settings done before will be retained even if you set other menu item settings after that. If [EXPOSURE] is set after [AE SHIFT] is set manually, [EXPOSURE] will override [AE SHIFT].
- If you select [RESET] in step ②, all the settings set manually return to the default setting.

💡 Tips

- During playback, you can adjust the volume using the RING.
- You can also assign menu items using [RING SETTING] (p. 45).

Recording in dark places (NightShot)

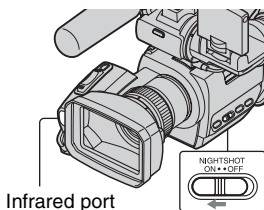

Set the NIGHTSHOT switch to ON (📺 and ["NIGHTSHOT"] appear).

🔗 Notes

- The NightShot and Super NightShot functions use infrared light. Therefore, do not cover the infrared port with your fingers or other objects and remove the conversion lens (optional).
- Adjust the focus manually ([FOCUS], p. 42) when it is hard to focus automatically.
- Do not use these functions in bright places. This may cause a malfunction.

Recording (Continued)

💡 Tips

- To record an image brighter, use Super NightShot function (p. 43). To record an image more faithful to the original colors, use Color Slow Shutter function (p. 43).

Adjusting the exposure for backlit subjects

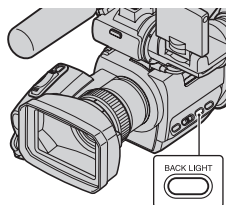

To adjust the exposure for backlit subjects, press BACK LIGHT to display . To cancel the back light function, press BACK LIGHT again.

Recording in mirror mode

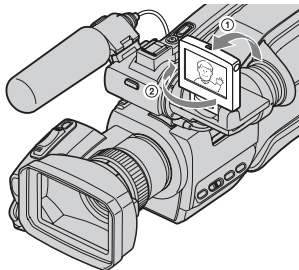

Open the LCD panel 90 degrees to the camcorder (①), then rotate it 180 degrees to the lens side (②).

💡 Tips

- A mirror-image of the subject appears on the LCD screen, but the picture will be normal when recorded.

Playback

Slide the POWER switch to PLAY/EDIT while pressing the green button.

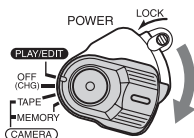

Playing movies



Touch to rewind to the desired scene, then touch to start playback.

Toggles Play or Pause as you touch*

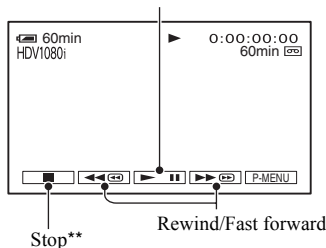

* Playback automatically stops if pause is engaged for more than 3 minutes.

** **MEMORY** is displayed instead of when a “Memory Stick Duo” with recorded images is inserted and a tape is not being played.

To adjust the sound volume

Touch **P-MENU** → **[VOLUME]**, then / to adjust the volume.

💡 Tips

- If you cannot find **[VOLUME]** in **P-MENU**, touch **[MENU]** → (STANDARD SET) → **[VOLUME]** (p. 55).

To search for a scene during playback

Touch and hold / during playback (Picture Search), or / while fast forwarding or rewinding the tape (Skip Scan).

💡 Tips

- You can play back in various modes (VAR.SPD PB, p. 52).

Viewing still images



Touch **MEMORY**.

The most recently recorded image is displayed.

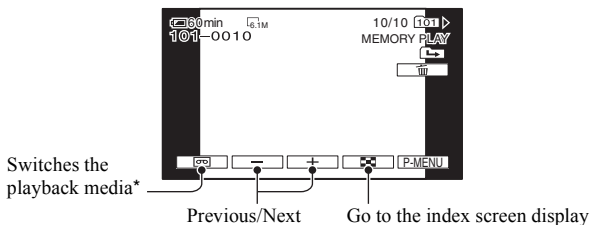

* **MEMORY** is displayed on the tape playback screen.

To display pictures on a “Memory Stick Duo” on the Index screen

Touch **[INDEX]**. Touch one of the pictures to back to the single display mode.

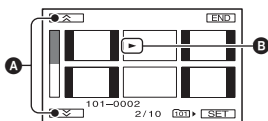

A Previous/Next 6 pictures

B The picture displayed before switching to the index screen

To view pictures in other folders, touch **[INDEX]** → **[SET]** → **[PB FOLDER]**, select a folder with **[↓]/[↑]**, then touch **[OK]** (p. 48).

Using PB zoom

You can magnify images from about 1.1 to 5 times (from about 1.5 to 5 times in still images) the original size.

Magnification can be adjusted with the power zoom lever.

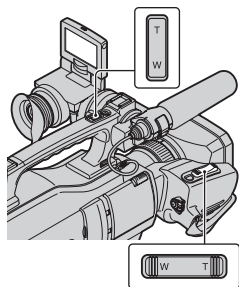

- ① Play back the picture you want to magnify.
- ② Magnify the picture with T (Telephoto).
- ③ Touch the screen at the point you want to display in the center of the displayed frame.
- ④ Adjust the magnification with W (Wide angle)/T (Telephoto).

To cancel, touch [END].

🔊 Notes

- While using PB zoom, images on the LCD panel and images that are output from the video signal are zoomed. The i.LINK output will not be affected.

Searching for the starting point

Searching for the last scene of the most recent recording (END SEARCH)

END SEARCH will not work once you eject the cassette after you have recorded on the tape.

Make sure that the POWER switch is set to TAPE.

Touch  → .

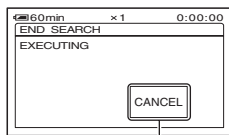

Touch here to cancel the operation.

The last scene of the most recent recording is played back for about 5 seconds, and the camcorder enters the standby mode at the point where the last recording has finished.

Notes

- END SEARCH will not work correctly when there is a blank section between recorded sections on the tape.

Tips

- You can also select [END SEARCH] from the menu. When the POWER switch is set to PLAY/EDIT, select the [END SEARCH] shortcut in Personal Menu (p. 36).

Reviewing the most recently recorded scenes (Rec review)

You can view about 2 seconds of the scene recorded just before you stopped the tape. Make sure that the POWER switch is set to TAPE.

Touch  → .

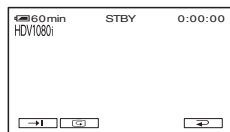

The last 2 seconds (approx.) of the most recently recorded scene are played back. Then, your camcorder is set to standby.

Playing the picture on a TV

Connection methods and image quality differ depending on what type of TV is connected and connectors used.

Use the supplied AC Adaptor as the power source (p. 15).

Refer also to the instruction manuals supplied with the device to be connected.

Notes

- Make all menu settings on your camcorder before connecting. The TV may not recognize the video signal properly if the [VCR HDV/DV] or [i.LINK CONV] setting is changed after the TV and your camcorder were connected with an i.LINK cable.
- Pictures recorded in the DV format are played back as SD (standard definition) images regardless of the connection.
- When recording, set [X.V.COLOR] to [ON] to play back on an x.v.Color-compliant TV (p. 45). Some settings may need to be adjusted on the TV when playing back.

Jacks on your camcorder

Open the jack cover in the direction of the arrow and connect the cable.

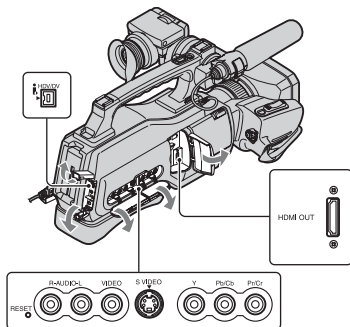

Lift up the bottom of the jack cover, then rotate in the direction of the arrow.

Playing the picture on a TV (Continued)

Connecting to a high definition TV

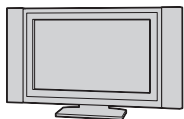

HD (high definition) image quality

- An HDV formatted picture is played back as it is (HD image quality).
- A DV formatted picture is played back as it is (SD image quality).

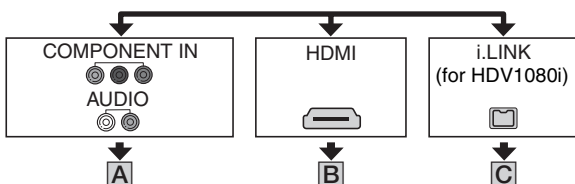

: Signal flow, () : Reference pages

Type	Camcorder	Cable	TV	Menu Setting
------	-----------	-------	----	--------------

A

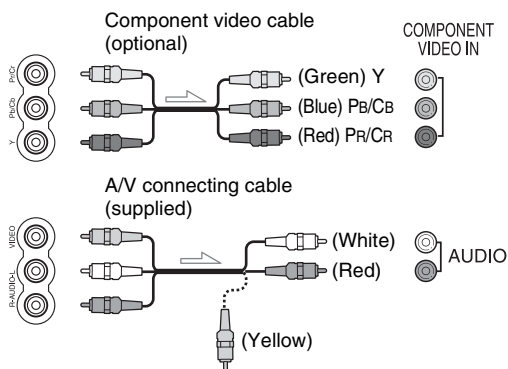

(STANDARD SET)
[VCR HDV/DV] →
[AUTO] (53)
[COMPONENT] →
[1080i/480i] (56)

- An A/V connecting cable is also needed to output audio signals. Connect the white and red plugs of the A/V connecting cable to the audio input jack of your TV.

↗ : Signal flow, () : Reference pages

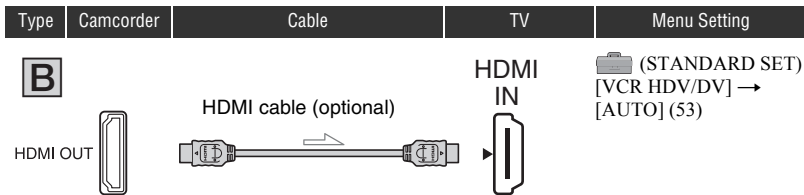

• **Use an HDMI cable with the HDMI logo (on the front cover).**

- Pictures in the DV format are not output from the HDMI OUT jack, if copyright protection signals are recorded in the pictures.
- DV format pictures input to the camcorder via i.LINK cable (p. 65) cannot be output.
- Your TVs may not function correctly (e.g., no sound or image). Do not connect the HDMI OUT jack of your camcorder and HDMI OUT jack of an external device with the HDMI cable. This may cause a malfunction.

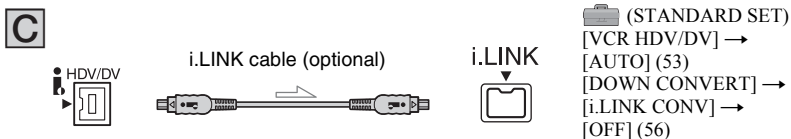

• **Your TV needs to have an i.LINK jack compatible with HDV1080i specification. For details, confirm the specifications of your TV.**

- If your TV is not compatible with HDV1080i specification, connect your camcorder and TV with the optional component video cable and supplied A/V connecting cable as illustrated in **A**.
- The TV needs to be set so that it recognizes that the camcorder is connected. See the instruction manuals supplied with your TV.

Connecting to a 16:9 (wide) or 4:3 TV

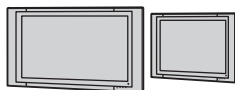

SD (standard definition) image quality

- An HDV formatted picture is down converted to DV format (SD image quality) and played back.
- A DV formatted picture is played back as it is (SD image quality).

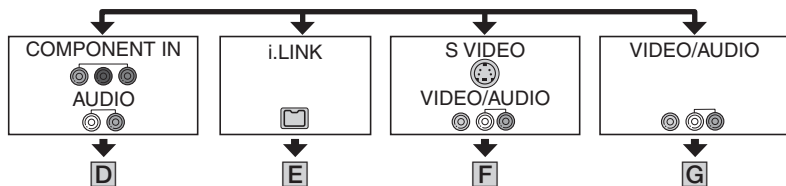

Playing the picture on a TV (Continued)





To set the aspect ratio according to the connected TV (16:9/4:3)



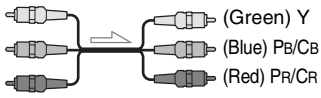
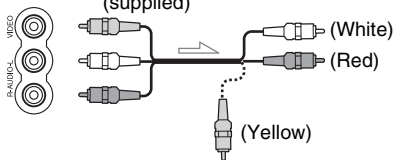

Change the [VIDEO OUT] setting to match your TV.

Notes

- When you play back a tape recorded in the DV format on a 4:3 TV not compatible with the 16:9 signal, set [WIDE SELECT] to [4:3] on your camcorder when recording a picture (p. 54).

 : Signal flow, () : Reference pages

Type	Camcorder	Cable	TV	Menu Setting
D		<p>Component video cable (optional)</p>  <p>(Green) Y (Blue) PB/CB (Red) PR/CR</p> <p>A/V connecting cable (supplied)</p>  <p>(White) (Red) (Yellow)</p>	<p>COMPONENT VIDEO IN</p>  <p>AUDIO</p> 	<p> (STANDARD SET) [VCR HDV/DV] → [AUTO] (53) [COMPONENT] → [480i] (56) [DOWN CONVERT] → [VIDEO OUT] → [SQUEEZE]/[LETTER BOX]/[EDGE CROP] (56)</p>
				<p>• A/V connecting cable is also needed to output audio signals. Connect the white and red plugs of the A/V connecting cable to the audio input jack of your TV.</p>

E		<p>i.LINK cable (optional)</p> 	<p>i.LINK</p> 	<p> (STANDARD SET) [VCR HDV/DV] → [AUTO] (53) [DOWN CONVERT] → [i.LINK CONV] → [ON:SQUEEZE]/ [ON:EDGE CROP] (56)</p>
				<p>• The TV needs to be set so that it recognizes that the camcorder is connected. See the instruction manuals supplied with your TV.</p>

↗ : Signal flow, () : Reference pages

Type	Camcorder	Cable	TV	Menu Setting
------	-----------	-------	----	--------------

F

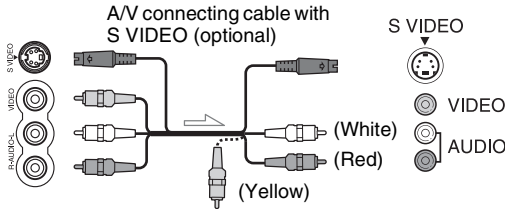

(STANDARD SET)
 [VCR HDV/DV] →
 [AUTO] (53)
 [DOWN CONVERT] →
 [VIDEO OUT] →
 [SQUEEZE]/[LETTER BOX]/[EDGE CROP] (56)

- When connecting only an S VIDEO plug (S VIDEO channel), audio signals are not output. To output audio signals, connect the white and red plugs of the A/V connecting cable with an S VIDEO cable to the audio input jack of your TV.
- This connection produces higher resolution pictures compared with the A/V connecting cable (Type **G**).

G

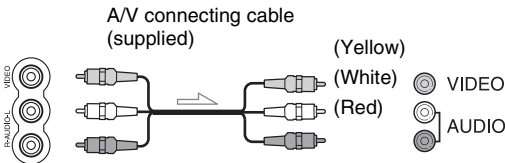

(STANDARD SET)
 [VCR HDV/DV] →
 [AUTO] (53)
 [DOWN CONVERT] →
 [VIDEO OUT] →
 [SQUEEZE]/[LETTER BOX]/[EDGE CROP] (56)

When connecting to your TV via a VCR

Select one of the connecting methods on page 62, according to the input jack of the VCR. Connect your camcorder to the LINE IN input on the VCR using the A/V connecting cable. Set the input selector on the VCR to LINE (VIDEO 1, VIDEO 2, etc.).

When your TV is monaural (When your TV has only one audio input jack)

Connect the yellow plug of the A/V connecting cable to the video input jack and connect the white (left channel) or the red (right channel) plug to the audio input jack of your TV or VCR.

💡 Tips

- The HDMI (High Definition Multimedia Interface) is an interface to send both video/audio signals. Connecting HDMI OUT jack and external device with a cable supplies high quality images and digital audio.
- If you connect your camcorder to your TV using more than one type of cable to output images from a jack other than the i.LINK jack, the order of priority of the output signals is as follows: HDMI → component video → S VIDEO → audio/video.
- See page 93 for the details of i.LINK.

Using the menu items

- 1** Slide the **POWER** switch to the desired position while pressing the green button.

TAPE:  settings on a tape

MEMORY:  settings on a “Memory Stick Duo”

PLAY/EDIT: settings for viewing/editing

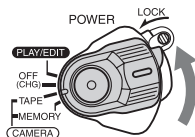

- 2** Touch the LCD screen to select the menu item.

Unavailable items will be grayed out.

■ To use the short-cuts of Personal Menu

On Personal Menu, short-cuts for frequently used menu items are added.



💡 Tips

- You can customize Personal Menu as you like (p. 60).

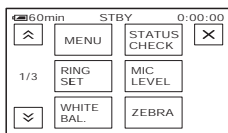
- ① Touch **P.MENU**.



- ② Touch the desired item.

If the desired item is not displayed on the screen, touch / until the item is displayed.



- ③ Select the desired setting, then touch **OK**.

■ To use menu items

You can customize menu items that are not added to Personal Menu.

- ① Touch **P.MENU** → [MENU].

- ② Select the desired menu.

Touch / to select the item, then touch **OK**. (The process in step ③ is the same as that in step ②).

- ③ Select the desired item.





- ④ Customize the item.

After finishing the settings, touch **OK** →  (close) to hide the menu screen.









If you decide not to change the setting, touch  to return to the previous screen.

Menu items

Available menu items (●) vary depending on the position of the switch.

	Position	TAPE	MEMORY	PLAY/EDIT
 CAMERA SET menu (p. 39)				
SCENE SELECT		●	●	—
SPOT METER		●	●	—
EXPOSURE		●	●	—
WHITE BAL.		●	●	—
SHARPNESS		●	●	—
SHUTTR SPEED		●	●	—
AUTOSLW SHTR		●	—	—
AE SHIFT		●	●	—
CAMERA COLOR		●	●	—
WB SHIFT		●	●	—
SPOT FOCUS		●	●	—
FOCUS		●	●	—
TELE MACRO		●	●	—
SUPER NS		●	—	—
NS LIGHT		●	●	—
COLOR SLOW S		●	●	—
ZEBRA		●	●	—
HISTOGRAM		●	●	—
SELF-TIMER		●	●	—
DIGITAL ZOOM		●	—	—
STEADYSHOT		●	●	—
CONV.LENS		●	●	—
RING SETTING		●	●	—
X.V.COLOR		●	—	—
 MEMORY SET menu (p. 46)				
STILL SET		—	●	●
 ALL ERASE		—	—	●
 FORMAT		—	●	●
FILE NO.		—	●	●
NEW FOLDER		—	●	●
REC FOLDER		—	●	●
PB FOLDER		—	—	●
 PICT.APPLI. menu (p. 49)				
FADER		●	—	—
INT.REC-STL		—	●	—
SLIDE SHOW		—	—	●
D.EFFECT		●	—	●
PICT.EFFECT		●	—	●
SMTH SLW REC		●	—	—
PictBridge PRINT		—	—	●

Menu items (Continued)

	Position	TAPE	MEMORY	PLAY/EDIT
USB SELECT		–	–	●
 EDIT/PLAY menu (p. 52)				
 VAR.SPD PB		–	–	●
 REC CTRL		–	–	●
END SEARCH		●	–	●
 STANDARD SET menu (p. 53)				
VCR HDV/DV		–	–	●
REC FORMAT		●	–	–
DV SET 		●	–	●
VOLUME		●	●	●
MIC LEVEL		●	–	–
AU.LVL DISP		●	–	–
LCD/VF SET		●	●	●
COMPONENT		●	●	●
DOWN CONVERT		●	●	●
STATUS CHECK		●	–	●
GUIDEFAME		●	●	–
COLOR BAR		●	–	–
DATA CODE		–	–	●
 REMAINING		●	–	●
REC LAMP		●	●	–
BEEP		●	●	●
DISP OUTPUT		●	●	●
MENU ROTATE		●	●	●
CALIBRATION		–	–	●
QUICK REC 		●	–	–
 TIME/LANGU. menu (p. 59)				
CLOCK SET		●	●	●
WORLD TIME		●	●	●
LANGUAGE		●	●	●

CAMERA SET menu

Settings to adjust your camcorder to the recording conditions

The default settings are marked with ►. The indicators in parentheses appear when the items are selected.

See page 36 for details on selecting menu items.

SCENE SELECT

You can record pictures effectively in various situations with the [SCENE SELECT] function.

► AUTO

Select to automatically record pictures effectively without the [SCENE SELECT] function.

TWILIGHT* (☾)

Select to maintain the darkening atmosphere of the distant surroundings in twilight scenes.



CANDLE (🕯)

Select to maintain the dim atmosphere of a candlelit scene.



SUNRSE SUNSET (Sunrise and sunset)* (☀)

Select to maintain the atmosphere of situations such as sunsets and sunrises.



FIREWORKS* (💣)

Select to record all the splendor of fireworks.



LANDSCAPE* (🏞)

Select to shoot distant subjects clearly. This setting also prevents your camcorder from focusing on glass or metal mesh in windows between the camcorder and the subject.



PORTRAIT (Soft portrait) (👤)

Select to bring out the subject such as people or flowers while creating a soft background.



SPOTLIGHT** (🎤)

Select to prevent people's faces from appearing excessively white when subjects are lit by strong light.



BEACH** (🏖)

Select to prevent people's faces from appearing dark in strong light or reflected light, such as at a beach in midsummer.



SNOW** (❄)

Select this when shooting in very bright, white conditions, such as on a ski slope; otherwise picture may appear too dark.



* Adjusted to focus on subjects farther away only.

** Adjusted not to focus on subjects a short distance away.

Notes

- If you set [SCENE SELECT], the settings of [SHUTTR SPEED] and [WHITE BAL.] are canceled.

SPOT METER (Flexible spot meter)

You can adjust and fix the exposure to the subject, so that it is recorded in suitable brightness even when there is strong contrast between the subject and the background, such as subjects in the spotlight on stage.

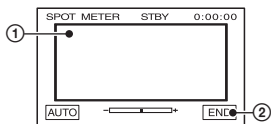

- Touch the point where you want to fix and adjust the exposure on the screen.

— appears.

- Touch [END].

To return the setting to automatic exposure, touch [AUTO] → [END].

Notes

- If you set [SPOT METER], [EXPOSURE] is automatically set to [MANUAL].

EXPOSURE

You can fix the brightness of a picture manually. Adjust the brightness when the subject is much brighter or darker than the background.

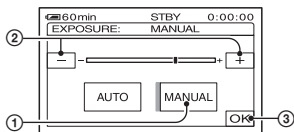

- Touch [MANUAL].

— appears.

- Adjust the exposure by touching [−]/[+].

- Touch [OK].

To return the setting to automatic exposure, touch [AUTO] → [OK].

Tips

- You can also adjust the setting manually using the RING (p. 25).

WHITE BAL. (White balance)

You can adjust the color balance to the brightness of the recording environment.

AUTO

The white balance is adjusted automatically.

OUTDOOR (☀)

The white balance is appropriately adjusted for the following recording conditions:

- Outdoors
- Night views, neon signs and fireworks
- Sunrise or sunset
- Under daylight fluorescent lamps

INDOOR (☾)

The white balance is appropriately adjusted for the following recording conditions:

- Indoors
- At party scenes or studios where the lighting conditions change quickly
- Under video lamps in a studio, or under sodium lamps or incandescent-like color lamps

ONE PUSH (👉)

The white balance will be adjusted according to the ambient light.

- Touch [ONE PUSH].
- Frame a white object such as a piece of paper, to fill the screen under the same lighting conditions as you will shoot the subject.

- ③ Touch [BAL].
BAL flashes quickly. When the white balance has been adjusted and stored in the memory, the indicator stops flashing.

Notes

- Set [WHITE BAL.] to [AUTO] or adjust the color in [ONE PUSH] under white or cool white fluorescent lamps.
- When you select [ONE PUSH], keep framing white objects while BAL is flashing quickly.
- BAL flashes slowly if [ONE PUSH] could not be set.
- When [ONE PUSH] was selected, if BAL keeps flashing after touching [OK], set [WHITE BAL.] to [AUTO].
- If you set [WHITE BAL.], [SCENE SELECT] returns to [AUTO].

Tips

- If you have changed the battery pack while [AUTO] was selected, or taken your camcorder outdoors after inside use (or vice versa), select [AUTO] and aim your camcorder at a nearby white object for about 10 seconds for better color balance adjustment.
- When the white balance has been set with [ONE PUSH], if you change the [SCENE SELECT] settings, or bring your camcorder outdoors from inside the house, or vice versa, you need to redo the [ONE PUSH] procedure to readjust the white balance.

SHARPNESS

You can adjust the sharpness of the image outline with [-]/[+]. [L] appears when the sharpness is anything other than the default setting.



SHUTTER SPEED

You can manually adjust and fix the shutter speed for your convenience. Depending on the shutter speed, you can make the subject look still, or emphasize movement of the subject.

AUTO

Select to adjust the shutter speed automatically.

MANUAL(S)

Adjust the shutter speed using [-]/[+].

You can select a shutter speed between 1/3 and 1/10000 second when the POWER switch is set to TAPE, and between 1/4 and 1/500 second when the POWER switch is set to MEMORY.



Notes

- When the shutter speed is set between 1/725 to 1/10000 second, still images cannot be recorded.
- For example, if you select 1/100 second, [100] appears on the screen.
- At a slow shutter speed, automatic focus may be lost. Adjust the focus manually, using a tripod, etc.
- When recording under a discharge tube such as a fluorescent lamp, sodium lamp or mercury lamp, horizontal bands may appear in the screen depending on the shutter speed.

Tips

- You can also adjust the setting manually using the RING (p. 25).

AUTOSLW SHTR (Auto slow shutter)



When you set [AUTOSLW SHTR] to [ON], the shutter speed is slowed down automatically to 1/30 second in dark places.

AE SHIFT



You can adjust the exposure using [-] (dark)/[+] (bright). [AS] and the setting value appear when [AE SHIFT] is anything other than the default setting.



CAMERA SET menu (Continued)

Tips



- Touch  if the subject is white or the backlight is bright, or touch  if the subject is black or the light is dim.
- You can adjust the automatic exposure level to brighter or darker when [EXPOSURE] is set to [AUTO].
- You can also adjust the setting manually using the RING (p. 25).

CAMERA COLOR

You can adjust the color intensity with  / .  appears when [CAMERA COLOR] is anything other than the default setting.

  
Decreases color intensity ← → Increases color intensity

WB SHIFT (White Balance Shift)

You can adjust the white balance to the desired setting using  / .  and the setting value appear when [WB SHIFT] is anything other than the default setting.

Tips

- When the white balance is set to a lower value, pictures appear bluish, and when set to a higher value, pictures appear reddish.
- You can also adjust the setting manually using the RING (p. 25).

SPOT FOCUS

You can select and adjust the focal point to a subject not located in the center of the screen.

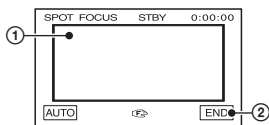

- ① Touch the subject on the screen.

 appears.

- ② Touch [END].

To adjust the focus automatically, touch [AUTO] → [END] in step ①.

Notes

- If you set [SPOT FOCUS], [FOCUS] is automatically set to [MANUAL].





FOCUS

You can adjust the focus manually. You can select this function also when you want to focus on a certain subject intentionally.



- ① Touch [MANUAL].

 appears.

- ② Touch  (focusing on close subjects) /  (focusing on distant subjects) to sharpen the focus.  appears when the focus cannot be adjusted any closer, and  appears when the focus cannot be adjusted farther away.

- ③ Touch [OK].

To adjust the focus automatically, touch [AUTO] → [OK] in step ①.

Notes

- The minimum possible distance between camcorder and subject while maintaining sharp focus is about 1 cm (about 13/32 in.) for wide angle and about 80 cm (about 2 5/8 feet) for telephoto.

Tips

- It is easier to focus on the subject by moving the power zoom lever towards T (telephoto) to adjust the focus, then towards W (wide angle) to adjust the zoom for recording. When you want to record a subject at close range, move the power zoom lever to W (wide angle), then adjust the focus.
- You can also adjust the focus manually using the RING (p. 25).

TELE MACRO

This is useful to shoot small subjects, such as flowers or insects. You can blur out backgrounds and the subject stands out clearer.

When you set [TELE MACRO] to [ON] (T), the zoom (p. 24) moves to the top of the T (Telephoto) side automatically and allows for recording subjects at a close distance as down to about 45 cm (17 3/4 in.).



To cancel, touch [OFF], or zoom to wide-angle (W side).

Notes

- When recording a distant subject, focusing may be difficult and can take some time.
- Adjust the focus manually ([FOCUS], p. 42) when it is hard to focus automatically.

SUPER NS (Super NightShot)

The picture will be recorded at a maximum of 16 times the sensitivity of NightShot recording if you set [SUPER NS] to [ON] while the NIGHTSHOT switch (p. 25) is also set to ON.

[S] and ["SUPER NIGHTSHOT"] appear on the screen.

To return to the normal setting, set [SUPER NS] to [OFF], or set the NIGHTSHOT switch to OFF.

Notes

- Do not use NightShot/[SUPER NS] in bright places. This may cause a malfunction.
- Do not cover the infrared port with your fingers or other objects.
- Remove the conversion lens (optional).
- Adjust the focus manually ([FOCUS], p. 42) when it is hard to focus automatically.

- The shutter speed of your camcorder changes depending on the brightness. The motion of the picture may slow down in this case.

NS LIGHT (NightShot Light)

When using either the NightShot (p. 25) or [SUPER NS] (p. 43) function to record, you can record clearer pictures by setting [NS LIGHT], which emits infrared light (invisible), to [ON] (the default setting).

Notes

- Do not cover the infrared port with your fingers or other objects.
- Remove the conversion lens (optional).
- The maximum shooting distance using [NS LIGHT] is about 3 m (10 feet).

COLOR SLOW S (Color Slow Shutter)

When you set [COLOR SLOW S] to [ON], you can record an image brighter in color even in dark places.

[C] and [COLOR SLOW SHUTTER] appear on the screen.

To cancel [COLOR SLOW S], touch [OFF].

Notes

- Adjust the focus manually ([FOCUS], p. 42) when it is hard to focus automatically.
- The shutter speed of your camcorder changes depending on the brightness. The motion of the picture may slow down at this time.

ZEBRA

Diagonal stripes appear in portions of the screen where brightness is at a preset level. This is useful as a guide when adjusting the brightness. When you change the default setting,  is displayed. The zebra pattern is not recorded.

▶ OFF

The zebra pattern is not displayed.

70

The zebra pattern appears at a screen brightness level of about 70 IRE.

100

The zebra pattern appears at a screen brightness level of about 100 IRE or higher.

🔊 Notes

- Portions of the screen where brightness is about 100 IRE or higher may appear overexposed.

💡 Tips

- IRE represents the screen brightness.

HISTOGRAM

When you set [HISTOGRAM] to [ON], the [HISTOGRAM] (a graph to display a distribution of tones in your picture) window appears on the screen.

This item is useful when you adjust exposure. You can adjust the [EXPOSURE] or [AE SHIFT] checking the [HISTOGRAM] window. The [HISTOGRAM] will not be recorded on a tape or “Memory Stick Duo.”

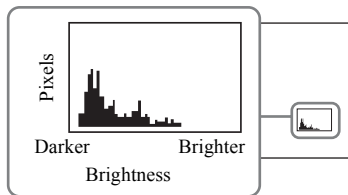

💡 Tips

- The left area on the graph shows the darker areas of the picture while the right area shows the brighter areas.

SELF-TIMER

A still image is recorded after about 10 seconds.

Press PHOTO when [SELF-TIMER] is set to [ON] and  appears.

To cancel the count down, touch [RESET].

To cancel the self-timer, select [OFF].

DIGITAL ZOOM

You can select the maximum zoom level in case you want to zoom to a level greater than 10 × (the default setting) while recording on a tape. Note that the image quality decreases when you are using the digital zoom.

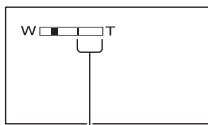

The right side of the bar shows the digital zooming factor. The zooming zone appears when you select the zooming level.

▶ OFF

Up to 10 × zoom is performed optically.

20 ×

Up to 10 × zoom is performed optically, and after that, up to 20 × zoom is performed digitally.

STEADYSHOT

You can compensate for camera shake (The default setting is [ON]). Set [STEADYSHOT] to [OFF] () when using a tripod (optional), then the image becomes natural.

CONV.LENS

When using an optional conversion lens, use this function to record using the optimum compensation for camera shake for each lens.

► OFF

Select this when the conversion lens (optional) is not used.

WIDE CONV. (W)

Select this to use the wide conversion lens (optional).

TELE CONV. (T)

Select this to use the tele conversion lens (optional).

RING SETTING

You can select a menu items to assign to the RING. For details, see page 25.

X.V.COLOR HDV1080i

When recording, set to [ON] to capture wider range of colors.

Various colors such as the brilliant color of flowers and turquoise blue of the sea can be more faithfully reproduced.

🔍 Notes

- Set [X.V.COLOR] to [ON] only when the recorded content will be played back on an x.v.Color-compliant TV. Otherwise, set to [OFF] (the default setting).
- If the movie recorded with this function [ON] is played back on a non-x.v.Color-compliant TV, the color may not be reproduced correctly.
- [X.V.COLOR] cannot be set to [ON] when:
 - Recording in DV format
 - A movie is being recorded.

MEMORY SET menu

Settings for the “Memory Stick Duo”

The default settings are marked with ►.
The indicators in parentheses appear when the items are selected.

See page 36 for details on selecting menu items.

STILL SET

■ QUALITY

► FINE (FINE)

Records still images at the fine image quality level.

STANDARD (STD)

Records still images at the standard image quality level.

■ IMAGE SIZE

► 6.1M (L6.1M)

Records still images clearly.

4.6M (L4.6M)

Records still images clearly in the 16:9 (wide) ratio.

3.1M (L3.1M)

Allows you to record more still images in relatively clear quality.

VGA (0.3M) (LVGA)

Allows for the maximum number of images to be recorded.

⚡ Notes

- [IMAGE SIZE] can be set only when the POWER switch is set to MEMORY.

Capacity of the “Memory Stick Duo” (MB) and the number of recordable pictures



When the POWER switch is set to MEMORY





	6.1M 2848 × 2136 L6.1M	4.6M 2848 × 1602 L4.6M	3.1M 2048 × 1536 L3.1M	VGA 640 × 480 LVGA
128MB	41 98	55 130	80 185	780 1970
256MB	75 175	95 235	140 335	1400 3550
512MB	150 360	200 480	295 690	2850 7200
1GB	310 730	415 980	600 1400	5900 14500
2GB	630 1500	850 2000	1200 2850	12000 30000
4GB	1250 2950	1650 3950	2400 5700	23500 59000
8GB	2500 6000	3350 8000	4900 11000	48000 115000

When the POWER switch is set to TAPE*

	4.6M 2848 × 1602 L4.6M	3.4M 2136 × 1602 L3.4M
128MB	55 130	74 170
256MB	95 235	130 305
512MB	200 480	270 630
1GB	415 980	550 1250
2GB	850 2000	1100 2600
4GB	1650 3950	2250 5200
8GB	3350 8000	4500 10000

When the POWER switch is set to PLAY/EDIT*

	1.2M 1440 x 810 	VGA 640 x 480 	0.2M 640 x 360 
128MB	205 490	780 1970	980 1970
256MB	370 890	1400 3550	1750 3550
512MB	760 1800	2850 7200	3600 7200
1GB	1550 3650	5900 14500	7300 14500
2GB	3150 7500	12000 30000	15000 30000
4GB	6300 14500	23500 59000	29500 59000
8GB	12500 30000	48000 115000	60000 115000

*  IMAGE SIZE] is fixed to  1.2M] in HDV format,  0.2M] in DV format (16:9) and  (VGA (0.3M)) in DV format (4:3).

Notes

- All numbers measured at the following settings:
Top: [FINE] is selected for image quality.
Bottom: [STANDARD] is selected for image quality.
- When using a “Memory Stick Duo” made by Sony Corporation. The number of pictures you can record varies depending on the recording environment and the recording media.
- The unique pixel array of Sony’s ClearVid CMOS sensor and image processing system (new Enhanced Imaging Processor) allows for still image resolution equivalent to the sizes described.

ALL ERASE

Deletes all the pictures without image protection on a “Memory Stick Duo” or in the selected folder.

- ① Select [ALL FILES] or [CURRNT FOLDER].

[ALL FILES]: Deletes all the images on the “Memory Stick Duo.”

[CURRNT FOLDER]: Deletes all the images in the selected folder.

- ② Touch [YES] twice → .

Notes

- The folder will not be deleted even when you delete all the pictures in the folder.
- Do not do any of the following while  Erasing all data... is displayed:
 - Operate the POWER switch/operation buttons.
 - Eject the “Memory Stick Duo.”

FORMAT

The “Memory Stick Duo” has been formatted at the factory, and does not require formatting at purchase.

To execute formatting, touch [YES] twice → . Formatting is completed, and all the images will be deleted.

Notes

- Do not do any of the following while  Formatting... is displayed:
 - Operate the POWER switch/operation buttons.
 - Eject the “Memory Stick Duo.”
- Formatting erases everything on the “Memory Stick Duo” including protected image data and newly created folders.

FILE NO.

► SERIES

Assigns file numbers in sequence even if the “Memory Stick Duo” is replaced with another one. The file number is reset when a new folder is created or the recording folder is replaced with another.

RESET

Resets the file number to 0001 each time the “Memory Stick Duo” is changed.

NEW FOLDER

You can create a new folder (102MSDCF to 999MSDCF) on a “Memory Stick Duo.” When 9,999 images are stored in the current folder, a new folder is automatically created for storing subsequent images.

Touch [YES] → [X].

Notes

- You cannot delete the created folders using your camcorder. You will have to format the “Memory Stick Duo” (p. 47), or delete them using your computer.
- The number of recordable pictures on a “Memory Stick Duo” may decrease as the number of folders increases.

REC FOLDER (Recording folder)

Select the folder to be used for recording with [▲]/[▼], then touch [OK].

Notes

- As the default setting, pictures are saved in the 101MSDCF folder.
- Once you record a picture in a folder, the same folder will be set as the default folder for playback.

PB FOLDER (Playback folder)

Select the playback folder with [▲]/[▼], then touch [OK].

PICT.APPLI. menu

Special effects on pictures or additional functions on recording/playback

The default settings are marked with ►.
The indicators in parentheses appear when the items are selected.

See page 36 for details on selecting menu items.

FADER

You can record a transition with the following effects adding to the interval between scenes.

- 1 Select the desired effect in [STBY] (to fading in) or [REC] (to fading out) mode, then touch [OK].
- 2 Press START/STOP.
The fader indicator stops flashing and disappears when the fade is complete.

To cancel before starting the operation, touch [OFF] in step 1.

Once you press START/STOP, the setting is canceled.



WHITE FADER



BLACK FADER



MOSAIC FADER



MONOTONE

When fading in, the picture gradually changes from black and white to color.
When fading out, it gradually changes from color to black and white.

INT.REC-STL (Interval photo recording)

You can record still images on the “Memory Stick Duo” at a selected interval. This function is useful to observe the movement of clouds or the changes in daylight, etc.

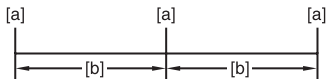

[a]: Recording

[b]: Interval

- 1 Touch [SET] → a desired interval time (1, 5 or 10 minutes) → [OK] → [ON] → [OK] → [X].
- 2 Press PHOTO fully.
The camera icon stops flashing and the interval still image recording starts.

To cancel [INT.REC-STL], select [OFF] in step 1.



SLIDE SHOW

Plays back in sequence the images stored on a “Memory Stick Duo,” or in a folder (slide show).

- 1 Touch [SET] → [PB FOLDER].
- 2 Select [ALL FILES (a)] or [CURRNT FOLDER (b)], then touch [OK].
If you select [CURRNT FOLDER (b)], all the images in the current playback folder selected in [PB FOLDER] (p. 48) are played back in sequence.
- 3 Touch [REPEAT].
- 4 Select [ON] or [OFF], then [OK].
To repeat the slide show, select [ON] (c).
To execute the slide show only once, select [OFF].
- 5 Touch [END] → [START].



To cancel [SLIDE SHOW], touch [END].
To pause, touch [PAUSE].

 **Tips**

- You can select the first picture for the slide show with  /  before touching [START].

D.EFFECT (Digital effect)

You can add digital effects to recording/playback.

- Touch the desired effect.
- Adjust the effect with  / , then touch [OK].

Effect	Items to adjust
CINEMA EFFECT*	No adjustment necessary
STILL	The degree of transparency of the still image you want to superimpose under a movie
FLASH	The interval of frame-by-frame recording/playback
TRAIL	The fade time of the incidental image
OLD MOVIE*	No adjustment necessary

* Available during tape recording only.

- Touch [OK].
 appears.

To cancel [D.EFFECT], touch [OFF] in step ①.

▶ **OFF**

Does not use [D.EFFECT] setting.

CINEMA EFFECT (Cinematic effect)

You can add a cinematic atmosphere to pictures by adjusting the image quality.

STILL

Records/plays back a movie while superimposing it on a still image memorized by touching [STILL].



FLASH (flash motion)

Records/plays back a movie with a serial-still-image effect (strobe effect).



TRAIL

When recording/playback, trailing after images are left in the picture.

OLD MOVIE

Adds an old movie effect with a sepia hue to pictures.

 **Notes**

- You cannot change to another digital effect while recording pictures on a tape with [CINEMA EFFECT] selected.
- Effects added to the playback pictures are not output via the  HDV/DV Interface (i.LINK). Only the original pictures can be output.
- While using [D.EFFECT], you cannot use the review button for still images on the “Memory Stick Duo” .
- If you set [CINEMA EFFECT], [SPOT METER] and [EXPOSURE] return to [AUTO].

 **Tips**

- You can save pictures edited using special effects on a “Memory Stick Duo” (p. 67) or record them on VCR or DVD/HDD recorders (p. 62).

PICT.EFFECT (Picture effect)

You can add special effects to a picture during recording or playback. **[P+]** appears.

► OFF

Does not use [PICT.EFFECT] setting.

SKINTONE*

Makes skin texture look more smoother and more appealing.

NEG.ART



The color and brightness are reversed.

SEPIA

Pictures appear in sepia.

B&W (Black and white)

Pictures appear in black and white.

SOLARIZE



Pictures appear as an illustration with strong contrast.

PASTEL *



Pictures appear as a pale pastel drawing.

MOSAIC*



Pictures appear mosaic-patterned.

* Available during tape recording only.

🔊 Notes

- Effects added to the playback pictures are not output via the **[i]** HDV/DV Interface (i.LINK). Only the original pictures can be output.

💡 Tips

- You can save pictures edited using special effects on a “Memory Stick Duo” (p. 67) or record them on VCR or DVD/HDD recorders (p. 62).

SMTH SLW REC (Smooth slow recording)

Fast moving subjects and actions, which cannot be captured under general shooting conditions, can be shot in smooth moving slow-motion for about 3 seconds.

This is useful to shoot fast actions such as a golf or tennis swing.

Press START/STOP on the [SMTH SLW REC] screen.

A 3 second-movie (approx.) is recorded as a 12 second slow-motion movie.

[Recording...] disappears, when recording is finished.

Touch **[SET]** to set the following.

– [TIMING]

Select the recording start point from the time START/STOP is pressed (The default setting is [3sec AFTER]).

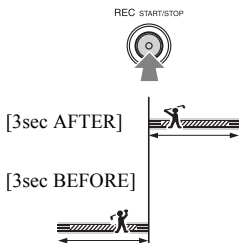

– [RECORD SOUND]

If you set to [ON] (**[G]**), you can record additional dialog, etc. to the slow-motion movie (The default setting is [OFF]).

Sounds are recorded while [Recording...] is displayed.

🔊 Notes

- Sounds cannot be recorded while shooting a 3 second-movie (approx.).

- The image quality of [SMTH SLW REC] is somewhat less than normal recording.

To cancel [SMTH SLW REC], select [END].

PictBridge PRINT

See page 69.

USB SELECT

You can connect the camcorder to a personal computer with a USB cable and import pictures to the computer. You can also connect the camcorder to a PictBridge compatible printer (p. 69) using this function.

Memory Stick

Select this to view pictures on a “Memory Stick Duo” on the computer or to import them to the computer.

PictBridge PRINT

Select this when you connect the camcorder to a PictBridge compatible printer to print out directly (p. 69).







Settings for editing or playing back in various modes

See page 36 for details on selecting menu items.

VAR.SPD PB (Various speed playback)

You can play back in various modes while viewing movies.

- ① Touch the following buttons during playback.

To	Touch
change the playback direction*	 (frame)
play back slowly**	 To reverse direction:  (frame) → 
play back frame by frame	 (frame) during playback pause. To reverse direction:  (frame) during frame playback.

* Horizontal lines may appear at the top, bottom, or in the center of the screen. This is not a malfunction.

** Pictures output from the  HDV/DV Interface (i.LINK) cannot be played back smoothly in slow mode.

- ② Touch  → .

To return to the normal playback mode, touch  (Play/Pause) twice (once from frame playback).

Notes

- You will not hear the recorded sound. You may see mosaic-like images of the previously played picture.
- Pictures in the HDV format are not output from the  HDV/DV Interface (i.LINK) when they are paused or played back in any mode other than normal playback mode.
- Pictures in the HDV format may appear distorted during:



STANDARD SET menu

Settings while recording on a tape or other basic settings

- Picture search
- Reverse playback
- Playing back slowly to the reverse direction and playing back frame by frame to the reverse direction are not available in HDV format.

REC CTRL (Movie recording control)

See page 65.

END SEARCH

EXEC

The most recently recorded picture is played back for about 5 seconds and then stops automatically.

CANCEL

Stops [END SEARCH].

Notes

- [END SEARCH] will not work once you eject the cassette after you have recorded on the tape.

VCR HDV/DV

Select the playback signal. Normally select [AUTO].

When your camcorder is connected to another device using an i.LINK cable, select the signal to input/output from the HDV/DV Interface (i.LINK). The selected signal is recorded or played back.

▶ AUTO

Switches the signals between HDV and DV format automatically when playing back a tape.

With an i.LINK connection, switches the signals between HDV and DV formats automatically, and inputs/outputs from the HDV/DV Interface (i.LINK).

HDV

Plays back only the portions recorded in HDV format.

With an i.LINK connection, inputs/outputs only HDV formatted signals from the HDV/DV Interface (i.LINK), and records/plays back. You can also select this when connecting the camcorder to a computer, etc.

DV

Plays back only the portions recorded in DV format.

With an i.LINK connection, inputs/outputs only DV formatted signals from the HDV/DV Interface (i.LINK), and records/plays back. You can also select this when connecting the camcorder to a computer, etc.

Notes

- Disconnect the i.LINK cable before changing the [VCR HDV/DV] setting. Otherwise, the connected device, such as a VCR, may not be

able to recognize the video signal from your camcorder.

- When [AUTO] is selected, if the signal switches between HDV and DV formats, the picture and sound are interrupted temporarily.
- When [i.LINK CONV] is set to [ON:SQUEEZE]/[ON: EDGE CROP], pictures are output as follows:
 - at [AUTO], an HDV signal is converted to the DV format and output; a DV signal is output as it is.
 - at [HDV], an HDV signal is converted to the DV format and output; a DV signal is not output.
 - at [DV], a DV signal is output as it is; an HDV signal is not output.

REC FORMAT

You can select a recording format.

▶ HDV1080i (HDV1080i)

Records in the HDV1080i specification.

DV (DV)

Records in the DV format.

⚙ Notes

- If you output the recording picture using an i.LINK cable, set [i.LINK CONV] accordingly.

DV SET DV

The following functions are available when recording in DV format.

■ REC MODE (Recording mode)

▶ SP (SP)

Records in the SP (Standard Play) mode on a cassette.

LP (LP)

Increases the recording time to 1.5 times the SP mode (Long Play).

⚙ Notes

- If you record in the LP mode, pictures may appear mosaic-like or sound may be interrupted when you play back the tape on other camcorders or VCRs.
- When you mix recordings in the SP mode and in the LP mode on one tape, the playback picture may be distorted or the time code may not be written properly between the scenes.

■ WIDE SELECT

You can select the aspect ratio according to the TV connected when recording. Refer also to the instruction manuals supplied with your TV.

▶ 16:9 WIDE

Records pictures in the full screen for a 16:9 (wide) TV screen.

4:3 (4:3)

Records pictures in the full screen for a 4:3 TV screen.

⚙ Notes

- Set [VIDEO OUT] correctly according to the TV connected for playback.

■ AUDIO MODE

▶ 12BIT

Records in the 12-bit mode (2 stereo sounds).

16BIT (16b)

Records in the 16-bit mode (1 stereo sound with high quality).

⚙ Notes

- When recording in the HDV format, sound is automatically recorded in [16BIT] mode.

■ AUDIO MIX

During tape playback, you can monitor the sound recorded by other camcorders using audio dubbing or 4ch microphone recording.

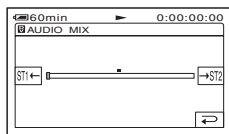

Touch **[ST1+]**/**[ST2]** to adjust the balance of the original sound (ST1) and the sound recorded afterwards (ST2), then touch **[OK]**.

Notes

- The original sound (ST1) is output at the default setting.

VOLUME

Touch **[−]**/**[+]** to adjust the volume (p. 27).

MIC LEVEL

You can adjust the recording sound level manually.

▶ AUTO

Select to adjust the recording sound level automatically.

MANUAL

When the MIC LEVEL is set to MANUAL, the **♪** icon is displayed.

Touch **[−]**/**[+]** to adjust the recording sound level during recording or standby.

The recording sound level adjustment bars appear on the screen. The recording sound level increases as the bar goes to the right. The recording level meter appears when the recording sound level is other than default setting.

Notes

- Use headphones to monitor the sound when adjusting it.

AU.LVL DISP (Audio level display)

Since the default setting is [ON], the audio level meter is displayed.

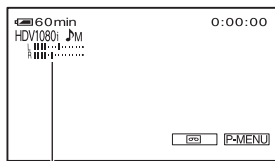

Audio level meter

LCD/VF SET

The recorded picture will not be affected by this operation.

■ LCD BRIGHT

You can adjust the brightness of the LCD screen.

- ① Adjust the brightness with **[−]**/**[+]**.
- ② Touch **[OK]**.

■ LCD BL LEVEL

You can adjust the brightness of the LCD screen's backlight.

▶ NORMAL

Standard brightness.

BRIGHT

Brightens the LCD screen.

Notes

- When you connect your camcorder to outside power sources, [BRIGHT] is automatically selected for the setting.
- When you select [BRIGHT], battery life is slightly reduced during recording.

■ LCD COLOR

You can adjust the color on the LCD screen with **[−]**/**[+]**.



VF B.LIGHT

You can adjust the brightness of the viewfinder.

▶ NORMAL

Standard brightness.

BRIGHT

Brightens the viewfinder screen.

VF COLOR

▶ ON

Display pictures in the viewfinder in color.

OFF

Display pictures in the viewfinder in black and white.

⚙ Notes

- When you connect your camcorder to outside power sources, [BRIGHT] is automatically selected for the setting.
- When you select [BRIGHT], battery life is slightly reduced during recording.

COMPONENT

Select [COMPONENT] when connecting your camcorder to a TV with the component input jack.

480i

Select when connecting your camcorder to a TV with the component input jack.

▶ 1080i/480i

Select when connecting your camcorder to a TV that has the component input jack and is capable of displaying the 1080i signal.

DOWN CONVERT

You can set an output video signal type from HDV format signals.

i.LINK CONV

When set to [ON:SQUEEZE]/[ON: EDGE CROP], converts the HDV signal to the DV format and output it from the  HDV/DV

Interface (i.LINK). The DV format signal is output unchanged.

▶ OFF

ON:SQUEEZE

Output signals to a 16:9 wide TV or a TV compatible with 16:9 wide mode.

On a 16:9 wide TV

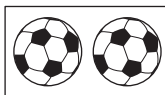

On a 4:3 TV compatible with 16:9 wide mode



ON: EDGE CROP

Display the center of the picture in 4:3 aspect ratio by cropping the both sides of the picture.

On a 4:3 standard TV

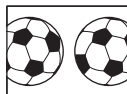

⚙ Notes

- For an i.LINK input, refer to “VCR HDV/DV” (p. 53).
- Be sure to disconnect the i.LINK cable before changing the setting. Otherwise, the connected device may not be able to recognize the video signal properly.

VIDEO OUT

You can set the HDV output format for the following outputs.

- COMPONENT (480i)
- S VIDEO
- AUDIO/VIDEO

► SQUEEZE

Output signals to a 16:9 wide TV or a TV compatible with 16:9 wide mode.

On a 16:9 wide TV



On a 4:3 TV compatible with 16:9 wide mode

**LETTER BOX**

Output signals to a TV that is not compatible with 16:9 wide mode.

On a 4:3 standard TV

**EDGE CROP**

Display the center of the picture in 4:3 aspect ratio by cropping the both sides of the picture.

On a 4:3 standard TV

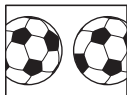
**⚡ Notes**

- When you view pictures that were recorded in the DV format with [P] WIDE SELECT set to [16:9 WIDE] on a 4:3 standard TV, pictures may appear as they are in height, but are compressed in width depending on the TV. If you view the recorded pictures on such type of 4:3 standard TV, set [P] WIDE SELECT to [4:3] before recording.

STATUS CHECK

You can check the setup value of the following items.

OUTPUT

- [VCR HDV/DV](when the POWER switch is set to PLAY/EDIT) (p. 53)
- [COMPONENT] (p. 56)
- [i.LINK CONV] (p. 56)
- [VIDEO OUT] (p. 56)
- HDMI OUT (p. 101)

HOURS METER

The cumulative operation time of your camcorder will be displayed with the total hours of operation, drum rotation, tape running, or the total number of tape unthreading operations.

- OPERATION

Displays the total hours of operation in 10-hour increments.

- DRUM RUN

Displays the total hours of drum rotation in 10-hour increments.

- TAPE RUN

Display the total hours of tape running in 10-hour increments.

- THREADING

Displays the total number of tape unthreading operations in 10-operation increments.

GUIDEFAME

You can display the frame and check that the subject is horizontal or vertical by setting [GUIDEFAME] to [ON]. The frame is not recorded. Press DISPLAY/BATT INFO to make the frame disappear.

💡 Tips

- Placing the subject at the cross point of the guide frame makes a balanced composition.

COLOR BAR

You can display the color bar or record it on the tape by setting [COLOR BAR] to [ON]. It is convenient to adjust the color on the monitor connected.

DATA CODE

During playback, displays the information (data code) recorded automatically at the time of recording.

▶ OFF

Data code is not displayed.

DATE/TIME

Displays the date and time.

CAMERA DATA (below)

Displays camera setting data.

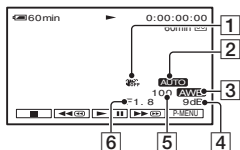

1 SteadyShot off

2 Exposure

3 White balance

4 Gain

5 Shutter speed

6 Aperture value

🔊 Notes

- The exposure adjustment value (0EV), a shutter speed, and the aperture value appear when still images on a "Memory Stick Duo" are played back.
- In the DATE/TIME data display, the date and time are displayed in the same area. If you record a picture without setting the clock, [--- -- ---] and [--:--:--] will appear.

🔋 REMAINING

▶ AUTO

Displays the remaining tape indicator for about 8 seconds in situations such as those described below.

- When you set the POWER switch to PLAY/EDIT or TAPE with a cassette inserted.
- When you touch (Play/Pause).

ON

Always displays the remaining tape indicator.

REC LAMP (Recording lamp)

The camera recording lamp will not light up during recording when you set this to [OFF] (The default setting is [ON]).

BEEP

▶ ON

A beeping sound starts when you start/stop recording, or operate the touch panel.

OFF

Cancels the beeping sound and shutter sound.

DISP OUTPUT (Display output)

▶ LCD PANEL

Shows displays such as the time code on the LCD screen and in the viewfinder.

V-OUT/PANEL

Shows displays such as the time code on the TV screen, LCD screen, and in the viewfinder.

MENU ROTATE

▶ NORMAL

Scrolls the menu items downwards by touching .

OPPOSITE

Scrolls the menu items upwards by touching .

CALIBRATION

See page 96.



menu

See page 36 for details on selecting menu items.

CLOCK SET

See page 18.

WORLD TIME

When using your camcorder abroad, you can set the time difference by touching  / , the clock will be adjusted in accordance with the time difference.

If you set the time difference to 0, the clock returns to the originally set time.

LANGUAGE

You can select the language to be used on the LCD screen.

- Your camcorder offers [ENG[SIMP]] (simplified English) for when you cannot find your native tongue among the options.

QUICK REC (Quick recording)

HDV1080i

You can slightly reduce the recording start point time when you start recording by pressing START/STOP. This function is useful to compensate for time lapse at the click of the shutter.

► OFF

Takes more time to reach the recording start point, but a smooth transition can be recorded.

ON (Q.REC)

Slightly reduces the time it takes to start recording when you attempt to record right after you switch on the camcorder (set the POWER switch to TAPE from the OFF (CHG) position), or when you attempt to record when the recording standby mode is canceled.

⚡ Notes

- If [QUICK REC] is set to [ON], the interval between scenes freezes for a moment (editing on your computer is recommended).

💡 Tips

- If the recording standby mode continues more than approximately 3 minutes, the drum will stop rolling, and the standby mode is canceled. This is to protect the tape and to prevent from unnecessarily battery exhausting.

Customizing Personal Menu

You can add desired menu items to any Personal Menu, and customize Personal Menu settings for each POWER switch position. This is convenient if you add frequently used menu items to Personal Menu.

Adding a menu item

You can add up to 28 menu items for each POWER switch position. Delete a less important menu item, if you want to add more.

1 Touch [P-MENU] → [P-MENU SET UP] → [ADD].

If the desired menu item is not displayed, touch \uparrow/\downarrow .

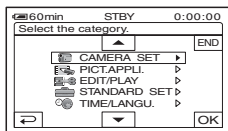

2 Touch \uparrow/\downarrow to select a menu category, then touch [OK].

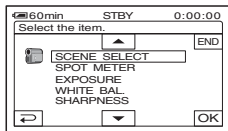

3 Touch \uparrow/\downarrow to select a menu item, then touch [OK] → [YES] → [X].

The menu item is added to the end of the list.

Deleting a menu item

1 Touch [P-MENU] → [P-MENU SET UP] → [DELETE].

If the desired menu item is not displayed, touch \uparrow/\downarrow .

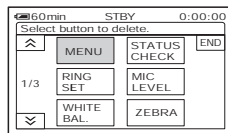

2 Touch the menu item that you want to delete.

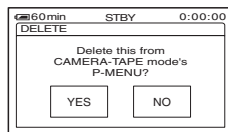

3 Touch [YES] → [X].

Notes

- You cannot delete [MENU] and [P-MENU SET UP].

Arranging the order of menu items displayed on Personal Menu

- 1 Touch **[P-MENU]** → **[P-MENU SET UP]** → **[SORT]**.

If the desired menu item is not displayed, touch **[▲]**/**[▼]**.

- 2 Touch the menu item you want to move.

- 3 Touch **[▲]**/**[▼]** to move the menu item to the desired place.

- 4 Touch **[OK]**.

To sort more items, repeat steps 2 to 4.

- 5 Touch **[END]** → **[X]**.

Notes

- You cannot move [P-MENU SET UP].

Initializing the Personal Menu settings (Reset)

- Touch **[P-MENU]** → **[P-MENU SET UP]** → **[RESET]** → **[YES]** → **[YES]** → **[X]**.

If the desired menu item is not displayed, touch **[▲]**/**[▼]**.

Dubbing to VCR or DVD/HDD recorders

Connect your camcorder to the wall outlet (wall socket) using the supplied AC Adaptor for this operation (p. 15). Refer also to the instruction manuals supplied with the devices to be connected.

Connecting to external devices

The connection method and the image quality will differ depending on the VCR or DVD/HDD recorders and the connectors used.

 : Signal flow

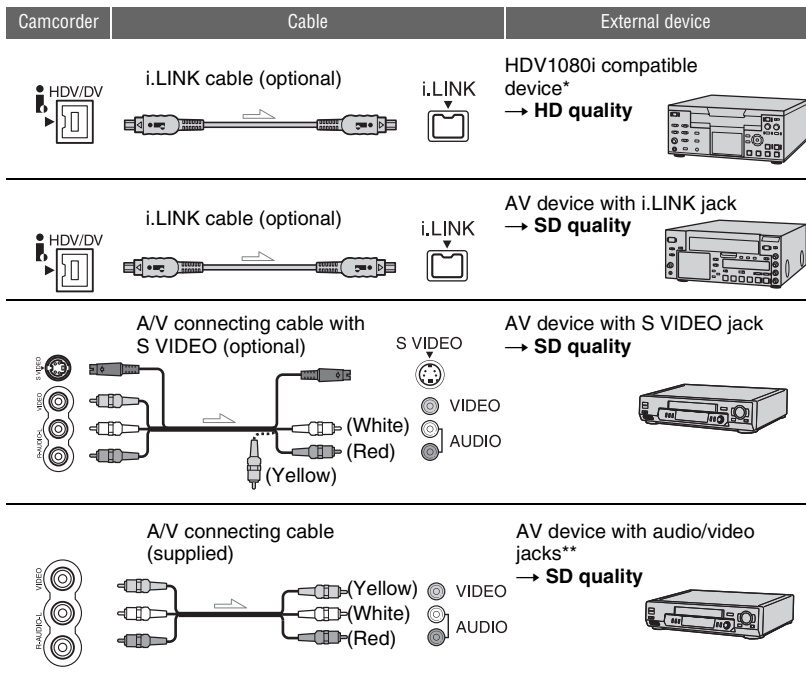

* An i.LINK jack which is compatible with HDV1080i specification is required. For details, refer to the instruction manuals supplied with the device to be connected.

** When connecting your camcorder to a monaural device, connect the yellow plug of the A/V connecting cable to the video jack on the device, and the white (left channel) or red (right channel) plug to the audio jack on the device.

Notes

- You cannot dub pictures using the HDMI cable.
- Pictures recorded in the DV format are dubbed as SD (standard definition) images, regardless of the connection.

Jacks on your camcorder

Open the jack cover and connect the cable.

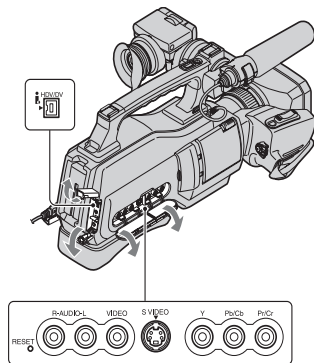

Using an i.LINK cable (optional)

Select the required settings from the table below and make the menu settings.

Notes

- Disconnect the i.LINK cable before changing these menu settings, otherwise the VCR or DVD/HDD recorders may not correctly identify the video signal.

Recorded format	Dubbing format	Menu setting	
		[VCR HDV/DV]	[i.LINK CONV]
HDV only	HDV* ¹	[AUTO] or HDV	[OFF]
	DV	[AUTO]	[ON: SQUEEZE]/ [ON:EDGE CROP]

Recorded format	Dubbing format	Menu setting	
		[VCR HDV/DV]	[i.LINK CONV]
Mixed HDV and DV	HDV* ¹	[AUTO] or HDV* ²	[OFF]
	DV	[AUTO]* ³	[ON: SQUEEZE]/ [ON:EDGE CROP]
DV only	DV	[AUTO] or DV	–

*¹ The VCR or DVD/HDD recorders need to be compliant with HDV1080i specification.

*² Parts recorded in DV format cannot be dubbed.

*³ Parts recorded in both DV and HDV format can be dubbed.

Notes

- When [VCR HDV/DV] is set to [AUTO], and the signal switches between HDV and DV formats, the picture and sound are interrupted temporarily.
- When the player and the recorder are both HDV1080i compatible devices such as HVR-HD1000U/HD1000N and are connected with the i.LINK cable, after pausing or stopping and then resuming the recording, the images will be unstable or rough at that point.
- Set [DISP OUTPUT] to [LCD PANEL] (default setting) when connecting with an A/V connecting cable (p. 58).

When connecting with the A/V connecting cable with an S VIDEO (optional)

Connect with S VIDEO jack instead of the video plug (yellow). This connection produces pictures more faithfully. The audio will not be output when you connect with the S VIDEO cable alone.

Dubbing to another device

1 Prepare your camcorder for playback.

Insert the recorded cassette.
Slide the POWER switch to PLAY/
EDIT.

2 When dubbing to the VCR, insert a cassette for recording. When dubbing to the DVD recorder, insert a DVD for recording.

If your recording device has an input selector, set it to the appropriate input (such as video input1 and video input2).

3 Connect your recording device (VCR or DVD/HDD recorder) to your camcorder.

See page 62 for connection details.





4 Start playback on your camcorder, and recording on the recording device.

Refer to the operating instructions supplied with your recording device for details.

5 When dubbing is complete, stop your camcorder and the recording device.

Notes

- When connecting with an A/V connecting cable, set [VIDEO OUT] according to the playback device (TV, etc.).

- To record the date/time and camera settings data when connected by the A/V connecting cable, display them on the screen (p. 58).
- The following cannot be output via the  HDV/DV interface (i.LINK):
 - Indicators
 - Pictures edited with [PICT.EFFECT] (p. 51) or [D.EFFECT] (p. 50)
 - Titles that are recorded on other camcorders
- Pictures recorded in the HDV format are not output from the  HDV/DV Interface (i.LINK) during playback pause or in any playback mode other than normal playback.
- Note the following when connecting with an i.LINK cable:
 - The recorded picture becomes rough when a picture is paused on your camcorder while recording to a VCR or DVD/HDD recorder.
 - Data codes (date/time/camera settings data) may not be displayed or recorded depending on the device or application.
 - You cannot record the picture and sound separately.
- When dubbing to a DVD recorder from your camcorder through an i.LINK cable, you may not operate your camcorder on your DVD recorder even if its instruction manual says you can.
If you can set the input mode to HDV or DV on your DVD recorder and can input/output pictures, follow the steps in “Dubbing to another device.”
- When you use an i.LINK cable, the video and sound signals are transmitted digitally, producing high quality pictures.
- When an i.LINK cable is connected, the format of the output signal (HDVout  or DVout ) will be indicated on the LCD screen of your camcorder.

Recording pictures from a VCR i.LINK

You can record movies from a VCR on a tape. You can record a scene as a still image on a "Memory Stick Duo." Be sure to insert a cassette or a "Memory Stick Duo" for recording in your camcorder beforehand. You can connect your camcorder to a VCR device using an i.LINK cable. Connect your camcorder to the wall outlet (wall socket) using the supplied AC Adaptor for this operation (p. 15). Refer also to the instruction manuals supplied with the devices to be connected.

HDV1080i
compatible device

AV device with
i.LINK output jack



→ HD quality

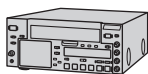

→ SD quality

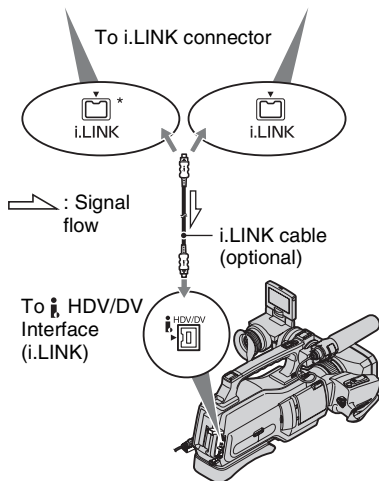

* An i.LINK jack which is compatible with HDV1080i specification is required.

Recording movies

1 Slide the **POWER** switch to **PLAY/EDIT**.

2 Set the input signal of your camcorder.

Set [VCR HDV/DV] to [AUTO] when recording from an HDV format compatible device.

Set [VCR HDV/DV] to [DV] or [AUTO] when recording from a DV format compatible device (p. 53).

3 Connect your VCR as a player to your camcorder.

Notes

- When an i.LINK cable is connected, the format of the input signal (**HDVIN i.LINK** or **DVIN i.LINK**) will be indicated on the LCD screen of your camcorder (This indicator may appear on the screen of the playback device, however, it will not be recorded).

4 Insert a cassette into the VCR.

5 Operate your camcorder to record movies.

Touch [F-MENU] → [REC CTRL] → [REC PAUSE].

If the desired item is not displayed on the screen, touch / until the item is displayed.

6 Start playing the cassette on your VCR.

The picture played on the connected device appears on the LCD screen of your camcorder.

7 Touch [REC START] at the point you want to start recording.

8 Stop recording.

Touch  (Stop) or [REC PAUSE].

9 Touch → .

Notes

- You need an i.LINK cable for this operation.
- You cannot record TV programs from the  HDV/DV Interface (i.LINK).
- You can record pictures from DV devices only in the DV format.
- Note the following when connecting with an i.LINK cable:
 - The recorded picture becomes rough when a picture is paused on a VCR while recording to your camcorder.
 - You cannot record the picture and sound separately.
 - If you pause or stop the recording and restart it, the picture may not be recorded smoothly.
- When a 4:3 video signal is input, it appears with black bands on the right and left sides on the screen of your camcorder.

Recording still images

1 Perform steps 1 to 4 in “Recording movies”.

2 Start playing the cassette.

The pictures on the VCR appear on the screen of your camcorder.

3 Press PHOTO lightly at the scene you want to record. Check the image and press it fully.

Dubbing pictures from a tape to a “Memory Stick Duo”



You can record a desired scene onto a “Memory Stick Duo” as a still image, from a movie you recorded on a tape. Make sure you have a recorded tape and a “Memory Stick Duo” inserted into your camcorder.

1 Slide the POWER switch to PLAY/EDIT.

2 Search and record the scene you want to record.

Touch  (Play) to play back the tape, then press PHOTO lightly at the scene you want to record. Check the image and press it fully.

Notes

- The date and time the picture is recorded on the tape and stored on the “Memory Stick Duo” are recorded. On your camcorder, the date and time the picture is recorded on the tape are displayed. Camera setting data recorded on the tape cannot be stored on the “Memory Stick Duo.”
- Still images will be fixed to image size  (1.2M) when playing back in the HDV format. Still images will be fixed to image size  (0.2M) (16:9) or  (VGA (0.3M)) (4:3) when playing back in the DV format (p. 47).
- You cannot record still images while using PB zoom.

Deleting recorded pictures from the “Memory Stick Duo”

1 Slide the POWER switch to PLAY/EDIT.

2 Touch .

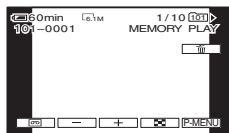



3 Select a picture you want to delete with / .

4 Touch → [YES].

Notes

- The pictures cannot be restored once they are deleted.
- Pictures cannot be deleted when a “Memory Stick Duo” with the write-protect tab is set to the write-protect position (p. 90), or when the selected picture is protected (p. 68).

Tips

- To delete all pictures at once, select  ALL ERASE] (p. 47).
- You can delete pictures on the index screen (p. 28). You can easily search for the picture to be deleted by displaying 6 pictures at once. Touch [SET] →  DELETE] → the picture you want to delete → [OK] → [YES].

Marking images on the “Memory Stick Duo” with specific information (Print mark/Image protection)

When you are using a “Memory Stick Duo” with the write-protect tab, make sure the write-protect tab on the “Memory Stick Duo” is not set to the write-protect position (p. 90).

Selecting still images for printing (Print mark)

The DPOF (Digital Print Order Format) standard is used to select images for printing on your camcorder. By marking images that you want to print out, you do not need to reselect them when you print them out (You cannot specify the number of printouts).

1 Slide the POWER switch to PLAY/EDIT.

2 Touch [MEMORY] →  → [SET] → [PRINT MARK].

3 Touch the image that you want to print out later.

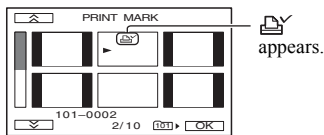

4 Touch [OK] → [END].

Notes

- To cancel Print mark, touch the image again to cancel Print mark in step 3.
- Do not mark images on your camcorder if the “Memory Stick Duo” already has some images with the Print mark put on using other devices. This may change the information of the images

with the Print mark put on using the other device.

Preventing accidental erasure (Image protection)

You can select and mark images to prevent accidental erasure.

1 Slide the POWER switch to PLAY/EDIT.

2 Touch [MEMORY] →  → [SET] → [PROTECT].

3 Touch the image that you want to protect.

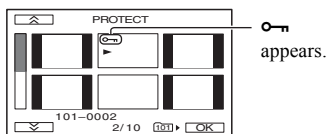

4 Touch [OK] → [END].

Notes

- To cancel image protection, touch the image again to cancel image protection in step 3.

Printing recorded images (PictBridge compliant printer)

You can print out pictures using a PictBridge compliant printer without connecting the camcorder to a computer.

PictBridge

Connect your camcorder to the AC Adaptor to obtain power from the wall outlet (wall socket) (p. 15).

Insert the “Memory Stick Duo” containing still images into your camcorder and turn on the printer.

Connecting your camcorder to the printer

1 Slide the **POWER** switch to **PLAY/EDIT**.

2 Connect the ψ (**USB**) jack of your camcorder to the printer using the **USB** cable.

[USB SELECT] appears on the screen automatically.

3 Touch **[PictBridge PRINT]**.

When connection is complete,  (PictBridge connecting) appears on the screen.

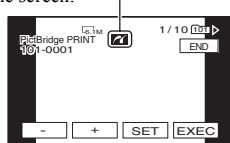



One of the images stored on the “Memory Stick Duo” will be displayed.

Notes

- We cannot guarantee the operation of models that are not PictBridge compatible.



Tips

- You can also operate by selecting in the following orders:
 - [P-MENU] → [MENU] →  (PICT.APPLI) → [USB SELECT] → [PictBridge PRINT].
 - [P-MENU] → [MENU] →  (PICT.APPLI) → [PictBridge PRINT].

Printing

1 Select the image to be printed with  / .

2 Touch **[SET]** → **[COPIES]**.

3 Select the number of copies to be printed with  / .

A maximum of 20 copies of the image can be printed.

4 Touch **[OK]** → **[END]**.

To print the date/time on the image, touch **[SET]** → **[DATE/TIME]** → **[DATE]** or **[DAY&TIME]** → **[OK]**.

5 Touch **[EXEC]** → **[YES]**.

When printing is finished, [Printing...] disappears and the image selection screen appears again.

Touch **[END]** when printing is completed.

Notes

- Refer also to the operating instructions for the printer to be used.
- Do not attempt the following operations when  is on the screen. The operations may not be performed properly.
 - Operate the **POWER** switch.

Printing recorded images (PictBridge compliant printer) (Continued)

- Disconnect the USB cable from the printer.
- Remove the “Memory Stick Duo” from your camcorder.
- If the printer stops working, disconnect the USB cable, turn the printer off and on again and restart the operation from the beginning.
- Some printers may cut off left, right, top and lower parts of the image. Especially, when the image is recorded with a 16:9 (wide) ratio, left and right parts may be largely cut off.
- Some printer models may not support the date/time printing function. Refer to your printer’s operating instructions for details.
- We cannot guarantee the printing of images recorded with a device other than your camcorder.
- PictBridge is an industry standard established by the Camera & Imaging Products Association (CIPA). You can print still images without using a computer by connecting a printer directly to a digital video camera or digital still camera, regardless of model or manufacturer.

Connecting to a computer

When connecting your camcorder to a computer, the following operations are available:

- Copying the still images on a “Memory Stick Duo” to the computer → p. 71
- Copying the movie on a tape in the HDV format to the computer → p. 74
- Copying the movie on a tape in the DV format to the computer → p. 74

About connection

There are 2 ways to connect your camcorder to a computer:

- USB cable
- To copy still images on a “Memory Stick Duo”
- i.LINK cable
- To copy movies on a tape

Notes on connecting to a computer

- When you are using a USB cable or an i.LINK cable to connect your camcorder to a computer, make sure to connect the connector in the correct direction. If you insert the connector forcibly, it may be damaged, and cause a malfunction of your camcorder.
- You cannot do the following:
 - Copying pictures on a tape to a computer with a USB cable.
 - Copying pictures on a “Memory Stick Duo” to a computer with an i.LINK cable.
- Remove the USB cable according to the correct procedure when disconnecting it from the computer (p. 73).

Copying still images to a computer

System requirements

For Windows users

- OS: Windows 2000 Professional/Windows XP Home Edition/Windows XP Professional/Windows Vista*

* Except for 64-bit version

It is necessary that your OS is factory-installed. Operations are not guaranteed if your OS has been upgraded or is being used in a multi-boot environment.

- CPU: MMX Pentium 200MHz or faster
- Others: USB port (provided as standard).

For Macintosh users

- OS: Mac OS 9.1/9.2 or Mac OS X (v10.1/v10.2/v10.3/v10.4)
- Others: USB port (provided as standard).

Step:1 Using the USB cable

- You can do this operation with the standard driver on your computer. You do not need to install any software.
- If your computer has a Memory Stick slot, insert the “Memory Stick Duo” on which pictures are recorded into the Memory Stick Duo adaptor (optional), then insert it into the Memory Stick slot on your computer to copy still images to the computer.
- When using a “Memory Stick PRO Duo” and your computer is not compatible with it, connect your camcorder with the USB cable instead of using the Memory Stick slot on the computer.

Copying still images to a computer (Continued)

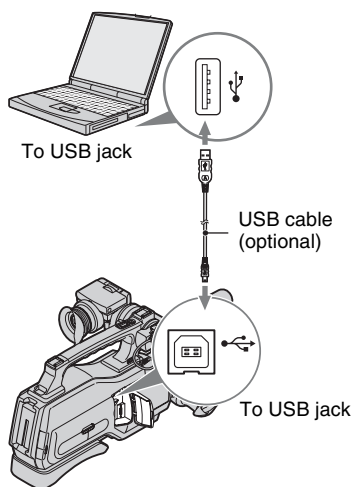

- Do not connect your camcorder to the computer at this point.
- The computer may not recognize the camcorder if you connect them with the USB cable before turning on your camcorder.
- See page 105 for the recommended connection.

1 Turn on the computer.

Close down all applications running on the computer.

For Windows 2000/Windows XP/ Windows Vista

Log on as an Administrator.

2 Insert a “Memory Stick Duo” into your camcorder.

3 Prepare the power source for your camcorder.

Use the supplied AC Adaptor to obtain AC power (p. 15).

4 Set the POWER switch to PLAY/ EDIT.

5 Touch [P-MENU] → [MENU] → [PICT.APPLI.] → [USB SELECT] → [Memory Stick].

6 Connect the USB cable to the (USB) jacks on your camcorder and your computer.

It may take a while until your computer recognizes your camcorder for the first time.

Step:2 Copying the pictures

For Windows users

Double-click the [Removable Disk] icon displayed in [My Computer]. Then, drag and drop a picture in the folder onto the hard disk drive of your computer.

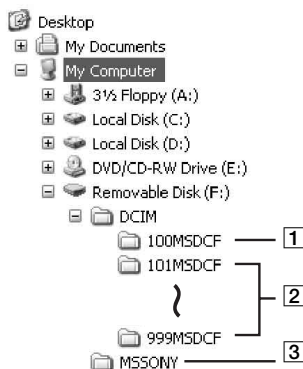

- 1 Folder containing image files recorded by other camcorders without the folder creation function (for playback only).
- 2 Folder containing image files recorded by your camcorder when no new folders have been created, only [101MSDCF] is displayed.
- 3 Folder containing movie data recorded by other camcorders without the folder creation function (for playback only)

Folder	File	Meaning
101MSDCF (up to 999 MSDCF)	DSC0□□□ □□.JPG	Still image file

□□□□ are numbers between 0001 and 9999.

For Macintosh users

Double-click the drive icon, then drag and drop the desired picture file onto the hard disk of your computer.

Disconnecting the USB cable

For Windows users

If [USB CONNECTING] appears on the LCD screen, follow the procedure below to disconnect the USB cable.

- 1 Click the [Unplug or eject hardware] icon on the task tray.

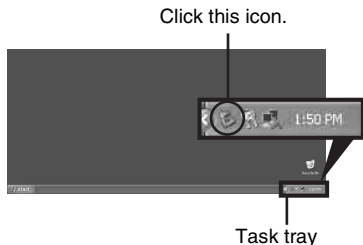

- 2 Click [Safely remove USB Mass Storage Device-Drive].

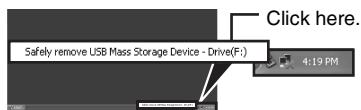

- 3 Click [OK].
 - 4 Disconnect the USB cable from the camcorder and computer.
- If [USB CONNECTING] does not appear on the LCD screen, do only step 4.

Notes

- Remove the USB cable according to the correct procedure, otherwise files in the “Memory Stick Duo” may not be updated correctly. Also, this may cause a malfunction of the “Memory Stick Duo.”

Copying still images to a computer (Continued)

For Macintosh users

- ① Close down all applications running on the computer.
- ② Drag and drop the drive icon on the desktop onto the [Trash] icon.
- ③ Disconnect the USB cable from the camcorder and computer.

Notes

- If you are using Mac OS X, turn off the computer before disconnecting the USB cable and ejecting the “Memory Stick Duo.”
- Do not disconnect the USB cable while the access lamp is lit.
- Make sure to disconnect the USB cable before turning off your camcorder.

Recommended connection

Observe the following points when connecting to ensure the camcorder operates correctly.

- Connect the camcorder to a computer via the USB cable. Make sure no other USB devices are connected to the computer.
- If your computer has a USB keyboard and a USB mouse as standard equipment, leave them connected and connect the camcorder to an available USB jack with the USB cable.
- Operation is not guaranteed if you connect two or more USB devices to the computer.
- Operation is not guaranteed if you connect the USB cable to the USB jack on a keyboard or USB hub.
- Make sure to connect the cable to the USB jack on the computer.
- Operation is not guaranteed even for the recommended environments.

Copying movies on a tape to a computer

Connect your camcorder to the computer with an i.LINK cable.

The computer needs to have an i.LINK connector and be installed with editing software that can copy video signals. The software required depends on the format of the recorded pictures and the format for copying to the computer (HDV or DV) as shown in the table below.

Recorded format	Format for copying to the computer	Required software
HDV	HDV	Editing software capable of copying HDV signal
HDV	DV	Editing software capable of copying DV signal
DV	DV	Editing software capable of copying DV signal

Notes

- You cannot copy movies using a USB cable.
- Refer to the operating instructions of the software for the details on image copying.
- Refer to the operating instructions of the editing software for the recommended connection.
- Some editing software on the computer may not work correctly.
- You cannot change format DV to HDV. The required menu settings vary depending on the recorded images and the format (HDV or DV) to be copied to the computer.

Recorded format	Format for copying to the computer	Menu setting*
HDV	HDV	[VCR HDV/DV] → [HDV] [i.LINK CONV] → [OFF]

Recorded format	Format for copying to the computer	Menu setting*
HDV	DV	[VCR HDV/DV] → [HDV] [i.LINK CONV] → [ON:SQUEEZE]/ [ON:EDGE CROP]
DV	DV	[VCR HDV/DV] → [DV] [i.LINK CONV] → [OFF]

* See page 36 for menu settings.

💡 Tips

- To copy HDV format images as they are without changing their format, an HDV compatible environment is required. For details, refer to your software instruction manual or contact the software manufacturer.
- To play movies by a regular DVD player, you need to create DVD video in the SD format. The DVD video is not in the HDV format.

Step:1 Connect an i.LINK cable

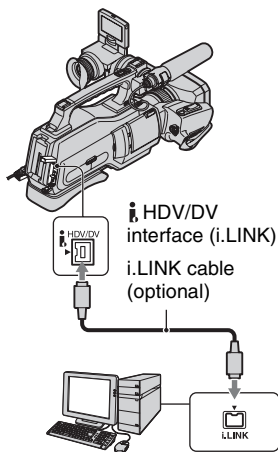

Notes on connecting to the computer

- Connect the i.LINK cable to the computer first, then to your camcorder. Connecting in the opposite order may cause static electricity to build up, resulting in a malfunction of your camcorder.
- The computer may freeze or may not recognize the signal from your camcorder in the following situations.
 - Connecting your camcorder to a computer that does not support the video signal formats appearing on the LCD screen of your camcorder display (HDV or DV).
 - Changing [VCR HDV/DV] (p. 53) and [i.LINK CONV] (p. 56) settings while connected with an i.LINK cable.
 - Changing [REC FORMAT] setting while connected with an i.LINK cable with the POWER switch set to TAPE or MEMORY (p. 54).
 - Changing the POWER switch position while connected with an i.LINK cable.

The format (HDV or DV) of input/output signal appears on the LCD screen of your camcorder while connected with an i.LINK cable.

Step:2 Copying the movies

Use the supplied AC Adaptor to obtain AC power (p. 15).

- Prepare editing software (not provided).
- Turn on your computer.
- Insert a tape into your camcorder and set the POWER switch to VCR.
- Set the menu of your camcorder. The menu settings vary depending on the copying image.
- Copy images to the computer with your software.

⚠️ Notes

- If images are copied in HDV format but not recognized, your editing software may not support HDV format. Convert the images to DV format according to step 4 and copy again.
- A tape recorded in DV format cannot be copied to a computer in HDV format.

Copying movies on a tape to a computer (Continued)

Tips

- When images recorded in HDV format are copied to a computer, the file size is about 2GB (almost the same as a DV file) for a 10-minute movie if the video compression format is MPEG2.

When copying the movie in the HDV format from the computer to your camcorder

Set [VCR HDV/DV] to [HDV] and [i.LINK CONV] to [OFF] (p. 53).

Notes

- To copy an HDV format movie edited on a computer back onto a tape in HDV format is possible so long as your editing software supports copying HDV movies onto tape. For details, contact the software manufacturer.

When copying the movie in the DV format from the computer to your camcorder

Set [VCR HDV/DV] to [DV] (p. 53).

Troubleshooting

If you run into any problems using your camcorder, use the following table to troubleshoot the problem. If the problem persists, disconnect the power source and contact your Sony dealer.

• Overall operations	77
• Batteries/Power sources	77
• LCD screen/viewfinder	78
• Cassette tapes/"Memory Stick Duo"	78
• Recording	79
• Playback	80
• Playing back on TV	81
• Dubbing/Editing/Connecting to other devices	82
• Functions that cannot be used together	83

Overall operations

The power does not turn on.

- Attach a charged battery pack to the camcorder (p. 15).
- Use the AC Adaptor to connect to a wall outlet (wall socket) (p. 15).

The camcorder does not operate even when the power is set to on.

- Disconnect the AC Adaptor from the wall outlet (wall socket) or remove the battery pack, then reconnect it after about 1 minute.
- Press the RESET button using a sharp-pointed object (If you press the RESET button, all settings are reset, except Personal Menu items).

The camcorder gets warm.

- The camcorder may get warmer while you use it. This is not a malfunction.

Batteries/Power sources

The power abruptly turns off.

- Charge the battery pack (p. 15).

The CHG (charge) lamp does not light while the battery pack is being charged.

- Slide the POWER switch to OFF (CHG) (p. 15).
- Attach the battery pack to the camcorder correctly (p. 15).
- Connect the power cord (mains lead) to the wall outlet (wall socket) properly.
- The battery charge is completed (p. 15).

The CHG (charge) lamp flashes while the battery pack is being charged.

- Attach the battery pack to the camcorder correctly (p. 15). If the problem persists, disconnect the AC Adaptor from the wall outlet (wall socket) and contact your Sony dealer. The battery pack may be damaged.

The remaining battery time indicator does not indicate the correct time.

- Ambient temperature is too high or too low, or the battery pack has not been charged enough. This is not a malfunction.
- Fully charge the battery again. If the problem persists, the battery may be worn-out. Replace it with a new one (p. 15, 92).
- The indicated time may not be correct in certain circumstances. For example, when you open or close the LCD panel, it takes about 1 minute to display the correct remaining battery time.

The battery pack discharges too quickly.



- Ambient temperature is too high or low, or the battery pack has not been charged enough. This is not a malfunction.
- Fully charge the battery again. If the problem persists, the battery may be worn-out. Replace it with a new one (p. 15, 92).

LCD screen/viewfinder

Menu items are grayed out.

- You cannot select grayed items in the current recording/playback situation.
- Depending on the functions, you may not be able to use them together (p. 83).

You cannot turn off the indicator.

- You cannot turn off . Touch  to check the warning messages (p. 86).

The buttons do not appear on the touch panel.

- Touch the LCD screen lightly.
- Press DISPLAY/BATT INFO on your camcorder (p. 19).

The buttons on the touch panel do not work correctly or do not work at all.

- Adjust the touch panel ([CALIBRATION]) (p. 96).

The picture in the viewfinder is not clear.

- Move the viewfinder lens adjustment lever until the picture appears clearly (p. 19).

The LCD screen does not turn on.

- Set the LCD ON/OFF switch to ON.

Cassette tapes/“Memory Stick Duo”

The cassette cannot be ejected from the compartment.

- Make sure the power source (battery pack or AC Adaptor) is connected correctly (p. 15).
- Moisture condensation has occurred inside the camcorder (p. 95).

The Cassette Memory indicator or title display does not appear while using a cassette with Cassette Memory.

- This camcorder does not support Cassette Memory, so the indicator does not appear.

The remaining tape indicator is not displayed.

- Set [ REMAINING] to [ON] to always display the remaining tape indicator (p. 58).

The cassette is noisier during rewinding or fast-forwarding.

- When using the AC Adaptor, rewind/fast forward speed increases (compared with battery operation) and therefore increases noise. This is not a malfunction.

You cannot operate functions using a “Memory Stick Duo,” even if a “Memory Stick Duo” is inserted.

- Slide the POWER switch to MEMORY or PLAY/EDIT (p. 18).
- If you use a “Memory Stick Duo” formatted on a computer, format it again on your camcorder (p. 47).

You cannot delete the recorded picture on the tape.

- You cannot delete a recorded picture on tape; you can only rewind the tape and record again. The new recording overwrites the existing one.

You cannot delete pictures or format a “Memory Stick Duo.”

- Cancel image protection on the picture (p. 68).
- The maximum number of pictures that you can delete on the index screen at one time is 100.

Image protection cannot be applied, or you cannot mark pictures for print.

- Release the lock on the write-protect tab of the “Memory Stick Duo” if there is one (p. 90).
- Perform the operation again on the index screen (p. 28, 68).
- The maximum number of pictures you can mark for print is 999.

The data file name is not indicated correctly, or flashes.

- The file is damaged.
- Use the file format compatible with your camcorder (p. 90).

Recording

Refer also to “Cassette tapes/“Memory Stick Duo”” section (p. 78).

The tape does not start when you press START/STOP.

- Slide the POWER switch to TAPE (p. 22).
- The tape has reached the end. Rewind it, or insert a new cassette.
- Set the write-protect tab to REC or insert a new cassette (p. 89).
- The tape is stuck to the drum due to moisture condensation. Remove the cassette and leave your camcorder for at least 1 hour, then reinsert the cassette (p. 95).

You cannot record on the “Memory Stick Duo.”

- The “Memory Stick Duo” is full. Insert another “Memory Stick Duo” or format the “Memory Stick Duo” (p. 47). Or, delete unnecessary pictures recorded on the “Memory Stick Duo” (p. 67).
- When the POWER switch is set to TAPE, you cannot record still images on the “Memory Stick Duo” with:
 - When [SHUTTR SPEED] is set between 1/725 to 1/10000 second
 - While executing [FADER]
 - [D.EFFECT]
 - [PICT.EFFECT]
 - [SMTH SLW REC]
 - [COLOR BAR]

The recording image view looks different.

- The recording image view may look different depending on the condition of your camcorder. This is not a malfunction.

You cannot record a smooth transition on a tape from the last recorded scene to the next.

- Perform END SEARCH (p. 30).
- Do not remove the cassette (The picture will be recorded continuously without a break even when you turn the power off).
- Do not record pictures in the HDV and DV formats on the same tape.
- Do not record pictures in SP mode and LP mode on the same tape. DV
- Avoid stopping then recording a movie in the LP mode. DV
- When [QUICK REC] is set to [ON], you cannot record a smooth transition (p. 59).
HDV1080i

[END SEARCH] does not work.

- Do not eject the cassette after recording (p. 30).
- There is nothing recorded on the cassette.

Troubleshooting (Continued)

- There is a blank section between recorded sections of the tape. This is not a malfunction.

[COLOR SLOW S] does not operate correctly.

- [COLOR SLOW S] may not operate correctly in total darkness. Use NightShot or [SUPER NS].

You cannot use [SUPER NS].

- The NIGHTSHOT switch is not set to ON (p. 25).

The auto focus does not function.

- Set [FOCUS] to [AUTO] (p. 42).
- The recording conditions are not suitable for auto focus. Adjust the focus manually (p. 42).

[STEADYSHOT] does not function.

- Set [STEADYSHOT] to [ON] (p. 44).

Tiny spots in white, red, blue, or green appear on the screen.

- The spots appear when the shutter speed is slow or when you are recording in [SUPER NS] or [COLOR SLOW S]. This is not a malfunction.

The subjects passing fast by the frame might appear crooked.

- This is called the focal plane phenomenon. This is not a malfunction. Because of the way the image device (CMOS sensor) reads out image signals, the subjects passing by the lens rapidly might appear crooked depending on the recording conditions.

The color of the picture is not correctly displayed.

- Deactivate the NightShot function (p. 25).

The screen picture is bright, and the subject does not appear on the screen.

- Set the NIGHTSHOT switch (p. 25) to OFF, or cancel the BACK LIGHT function (p. 26).

Horizontal bands appear.

- This may occur when recording pictures under lighting from a discharge tube, such as a fluorescent lamp, sodium lamp, or mercury lamp. This is not a malfunction.
- This may be alleviated by adjusting the shutter speed (p. 41).

Black bands appear when you record a TV screen or computer screen.

- Adjust [SHUTTR SPEED] (p. 41).

Playback

Refer also to “Cassette tapes/“Memory Stick Duo”” section (p. 78).

You cannot play back a tape.

- Slide the POWER switch to PLAY/EDIT.
- Rewind the tape (p. 27).

You cannot play back in reverse direction.

- Reverse playback is not possible with the tape recorded in the HDV format.

Image data stored on a “Memory Stick Duo” cannot be played back.

- Image data cannot be played back if you have modified file names or folders, or have edited the data on a computer (In this case, the file name flashes). This is not a malfunction (p. 91).

- Pictures recorded on other devices may not be played back or may not appear in their actual size. This is not a malfunction (p. 91).

Horizontal lines appear on the picture. The displayed pictures are not clear or do not appear.

- Clean the head using the cleaning cassette (optional) (p. 95).

You cannot hear the sound recorded with 4CH MIC REC on another camcorder. DV

- Adjust [ AUDIO MIX] (p. 54).

Fine patterns flicker, diagonal lines look jagged.

- Adjust [SHARPNESS] to the [] (soften) side (p. 41).

No sound or only a low sound is heard.

- Turn up the volume (p. 27).
- Adjust [ AUDIO MIX] from the [ST2] (additional sound) side until the sound is heard appropriately (p. 54).
- If you are using an S VIDEO plug or component video plug, make sure the red and white plugs of the A/V connecting cable are also connected (p. 31).
- Sounds cannot be recorded while shooting a 3 second-movie (approx.) using [SMTH SLW REC].

The picture or sound breaks off.

- The tape was recorded in both the HDV and DV formats. This is not a malfunction.

The movies freeze for a while, or the sound breaks off.

- This occurs if the tape or video head is dirty (p. 95).
- Use the Sony mini DV cassette.

“---” is displayed on the screen.

- The tape you are playing was recorded without setting the date and time.
- A blank section on the tape is being played.
- The data code on a tape with a scratch or noise cannot be read.

Noises appear and [PAL] or [50i] is displayed on the screen.

- The tape was recorded in a TV color system other than that of your camcorder (NTSC). This is not a malfunction (p. 88).

No picture appears during [END SEARCH] or Rec Review.

- The tape was recorded in both HDV and DV formats. This is not a malfunction.

4ch-12b appears on the LCD screen.

- This appears when you play back a tape recorded on other recording devices using a 4ch microphone (4CH MIC REC). This camcorder does not comply with the 4ch microphone recording standard.

Playing back on TV

You cannot view the picture on the TV connected with the i.LINK cable.

- You cannot view the picture in the HD (high definition) image quality on the TV which is not compatible with the HDV1080i specification (p. 31). Refer to the instruction manuals supplied with your TV.
- Down convert the pictures recorded in HDV format to DV format and play back in SD (standard definition) image quality (p. 56).
- Play back pictures using another connecting cable (p. 31).

You cannot view the picture or hear the sound on the TV connected with the component video cable.

- Set [COMPONENT] on the  (STANDARD SET) menu according to the requirements of the connected device (p. 56).
- When you are using the component video cable, make sure the red and white plugs of the A/V connecting cable are connected (p. 31).

You cannot view the picture or hear the sound on the TV connected with the HDMI cable.

- Pictures in the DV format are not output from the HDMI OUT jack, if copyright protection signals are recorded in the pictures.
- DV format pictures input to the camcorder via i.LINK cable (p. 65) cannot be output.
- This occurs if you record on a tape in both HDV and DV formats. Disconnect and connect the HDMI cable, or slide the POWER switch to turn on your camcorder again.

The picture appears distorted on a 4:3 TV.

- This happens when viewing a picture recorded in the 16:9 (wide) mode on a 4:3 TV. Set [VIDEO OUT] on the  (STANDARD SET) menu and play back the picture.

Black bands appear at the top and bottom on a 4:3 TV.

- This happens when viewing a picture recorded in 16:9 (wide) mode on a 4:3 TV. This is not a malfunction.

Dubbing/Editing/Connecting to other devices

Pictures from connected devices cannot be zoomed.

- You cannot zoom pictures from connected devices on your camcorder (p. 29).

Time code and other information appear on the display of the connected device.

- Set [DISP OUTPUT] to [LCD PANEL] while connected with an A/V connecting cable (p. 58).

You cannot dub correctly using the A/V connecting cable.

- You cannot input externally from a device connected with the A/V connecting cable.
- The A/V connecting cable is not connected properly.
Make sure that the A/V connecting cable is connected to the input jack of the other device for dubbing a picture from your camcorder.

When connected using an i.LINK cable, no picture appears on the monitor screen or the picture is distorted during dubbing.

- Set [VCR HDV/DV] on the  (STANDARD SET) menu according to the requirements of the connected device (p. 53).
- If the device to be connected is not compatible with HDV1080i specification, you cannot dub in HD (high definition) image quality (p. 62). For details, refer to the instruction manuals supplied with the device to be connected.
- Down convert the pictures recorded in HDV format to DV format and dub in SD (standard definition) image quality (p. 62).

You cannot add sound to the recorded tape.

- You cannot add sound to the recorded tape on this unit.

You cannot dub correctly using the HDMI cable.

- You cannot dub pictures using the HDMI cable.

New sound added to a recorded tape on another camcorder is not heard.

DV

- Adjust [ AUDIO MIX] from the [ST1] (original sound) side until the sound is heard appropriately (p. 54).

Still pictures cannot be dubbed from a tape to a “Memory Stick Duo.”

- You cannot record or a distorted picture may be recorded if the tape has been used repeatedly for recording.

Functions that cannot be used together

Depending on the functions, you may not be able to use them together. The following list shows examples of menu items and functions that cannot be used at the same time.

Not available	If this function is set
BACK LIGHT function	[FIREWORKS], [SPOT METER], [MANUAL] of [EXPOSURE]
[SCENE SELECT]	NightShot, [TELE MACRO], [CINEMA EFFECT], [OLD MOVIE], [COLOR SLOW S]
[SPOT METER]	NightShot, [CINEMA EFFECT]
[EXPOSURE]	NightShot

Not available	If this function is set
[WHITE BAL.]	NightShot
[SHARPNESS]	[CINEMA EFFECT]
[SHUTTR SPEED] of the RING	NightShot, [CINEMA EFFECT], [OLD MOVIE], [SMTH SLW REC]
[AE SHIFT]	[FIREWORKS], [MANUAL] of [EXPOSURE], [CINEMA EFFECT]
[SPOT FOCUS]	[SCENE SELECT]
[TELE MACRO]	[SCENE SELECT], during tape recording
[COLOR SLOW S]	NightShot, [SCENE SELECT], [MANUAL] of [SHUTTR SPEED], [FADER], [D.EFFECT]
[HISTOGRAM]	[DIGITAL ZOOM], [D.EFFECT], while displaying the date and time
[DIGITAL ZOOM]	[TELE MACRO]
[FADER]	[CANDLE], [FIREWORKS], [SUPER NS], [COLOR SLOW S], [D.EFFECT]
[D.EFFECT]	[SUPER NS], [COLOR SLOW S], [FADER]
[OLD MOVIE] of [D.EFFECT]	[SCENE SELECT], [PICT.EFFECT], when [ WIDE SELECT] is set to [4:3]

Troubleshooting (Continued)

Not available	If this function is set
[CINEMA EFFECT] of [D.EFFECT]	[SCENE SELECT], [SPOT METER], [MANUAL] of [EXPOSURE], other than 0 in [AE SHIFT], [PICT.EFFECT], when [ WIDE SELECT] is set to [4:3]
[SMTH SLW REC]	[CANDLE], [FIREWORKS], [MANUAL] of [SHUTTR SPEED], [SUPER NS], [COLOR SLOW S], [D.EFFECT], [PICT.EFFECT]

- When [COLOR BAR] is set, all the “Not available” menu items on the list are not available.

Warning indicators and messages

Self-diagnosis display/Warning indicators

If indicators appear on the LCD screen or in the viewfinder, check the following. Some symptoms you can fix by yourself. If the problem persists even after you have tried a couple of times, contact your Sony dealer or local authorized Sony service facility.

C:(or E:) □□:□□ (Self-diagnosis display)

C:04:□□

- The battery pack is not an “InfoLITHIUM” battery pack (L series). Use an “InfoLITHIUM” battery pack (L series) (p. 92).
- Connect the DC plug of the AC Adaptor to the DC IN jack of your camcorder securely (p. 15).

C:21:□□

- Moisture condensation has occurred. Remove the cassette and leave your camcorder for at least 1 hour, then reinsert the cassette (p. 95).

C:22:□□

- Clean the head using a cleaning cassette (optional) (p. 95).

C:31:□□ / C:32:□□

- Symptoms that are not described above have occurred. Remove and insert the cassette, then operate your camcorder again. Do not perform this procedure if moisture condensation has occurred (p. 95).
- Remove the power source. Reconnect it and operate your camcorder again.
- Change the cassette. Press RESET, and operate your camcorder again.

E:61:□□ / E:62:□□ / E:91:□□

- Contact your Sony dealer or local authorized Sony service facility. Inform them of the 5-digit code, which starts from “E.”

101-1001(Warning indicator pertaining to files)

- The file is damaged.
- The file is unreadable (p. 90).

⚡ (Battery level warning)

- The battery pack is nearly used up.
- Depending on the operating environment, or battery conditions, ⚡ may flash, even if there are approximately 5 to 10 minutes remaining.

📼 (Moisture condensation warning)*

- Eject the cassette, remove the power source, and then leave it for about 1 hour with the cassette lid open (p. 95).

📁 (Warning indicator pertaining to “Memory Stick Duo”)

- A “Memory Stick Duo” is not inserted (p. 20).

📁 (Warning indicators pertaining to “Memory Stick Duo” formatting)*

- The “Memory Stick Duo” is damaged.
- The “Memory Stick Duo” is not formatted correctly (p. 47, 90).

📁 (Warning indicator pertaining to incompatible “Memory Stick Duo”)

- An incompatible “Memory Stick Duo” is inserted (p. 90).

(Warning indicators pertaining to the tape)

Slow flashing:

- There is less than 5 minutes remaining on the tape.
- No cassette is inserted.*
- The write-protect tab on the cassette is set to lock (p. 89).*

Fast flashing:

- The tape has run out.*

(Eject cassette warning)*

Slow flashing:

- The write-protect tab on the cassette is set to lock (p. 89).

Fast flashing:

- Moisture condensation has occurred (p. 95).
- The self-diagnosis display code is displayed (p. 85).

(Warning indicator pertaining to image deletion)*

- The image is protected (p. 68).

(Warning indicator pertaining to the write-protect of the “Memory Stick Duo”)*

- The write-protect tab on the “Memory Stick Duo” is set to lock (p. 90).

(Warning indicator pertaining to camera-shake warning)





- The camcorder is unsteady, so camera-shake easily occurs. Hold the camcorder steady with both hands and shoot the image. However, note that the camera-shake warning indicator does not disappear.

* You hear a melody when the warning indicators appear on the screen (p. 58).



Description of warning messages

If messages appear on the screen, follow the instructions.

Tips

- When  is displayed, the message can be turned into  by touching . Touch  to display the message again.

■ Moisture condensation

  **Moisture condensation. Eject the cassette** (p. 95)

 **Moisture condensation. Turn off for 1H.** (p. 95)

■ Cassette/Tape

 **Reinsert the cassette.** (p. 20)

- Check if the cassette is damaged.

  **The tape is locked - check the tab.** (p. 89)

■ “Memory Stick Duo”

 **Reinsert the Memory Stick.** (p. 20)

- Reinsert the “Memory Stick Duo” a few times. If even then the indicator flashes, the “Memory Stick Duo” might be damaged. Try with another “Memory Stick Duo.”

 **This Memory Stick is not formatted correctly.**

- Check the format, then format the “Memory Stick Duo” as necessary (p. 47, 90).

Memory Stick folders are full.

- You cannot create folders exceeding 999MSDCF. You cannot delete created folders using your camcorder.
- You will have to format the “Memory Stick Duo” (p. 47), or delete them using your computer.

■ Dual Rec

Cannot save still picture.

- Do not eject “Memory Stick Duo” while still images are being stored onto it (p. 24).

■ PictBridge compliant printer

Check the connected device.

- Switch off the printer and switch it on again, then disconnect the USB cable and reconnect it.

Cannot print. Check the printer.

- Switch off the printer and switch it on again, then disconnect the USB cable and reconnect it.

Using your camcorder abroad

Power supply

You can use your camcorder in any country/region using the AC Adaptor supplied with your camcorder within the AC 100 V to 240 V, 50/60 Hz range. Use a commercially available AC plug adaptor [a], if necessary, depending on the design of the wall outlet [b].

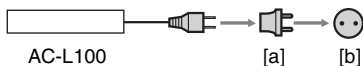

On TV color systems

Your camcorder is NTSC system, so its picture can only be viewed on an NTSC system TV with an AUDIO/VIDEO input jack.

System	Used in
NTSC	Bahama Islands, Bolivia, Canada, Central America, Chile, Colombia, Ecuador, Guyana, Jamaica, Japan, Korea, Mexico, Peru, Surinam, Taiwan, the Philippines, the U.S.A., Venezuela, etc.
PAL	Australia, Austria, Belgium, China, Czech Republic, Denmark, Finland, Germany, Holland, Hong Kong, Hungary, Italy, Kuwait, Malaysia, New Zealand, Norway, Poland, Portugal, Singapore, Slovak Republic, Spain, Sweden, Switzerland, Thailand, United Kingdom, etc.
PAL - M	Brazil
PAL - N	Argentina, Paraguay, Uruguay.
SECAM	Bulgaria, France, Guiana, Iran, Iraq, Monaco, Russia, Ukraine, etc.

Viewing HDV format pictures recorded in HDV format HDV1080i

You need an HDV1080i compatible TV (or monitor) with a component jack and AUDIO/VIDEO input jack. A component video cable and A/V connecting cable are also needed.

Viewing DV format pictures recorded in DV format DV

You need a TV (or monitor) with the AUDIO/VIDEO input jack. A connecting cable is also needed.

Simple setting of the clock by time difference

You can easily set the clock to the local time abroad by entering the time difference between where you live and where you are. Select [WORLD TIME] in the (TIME/LANGU.) menu, then set the time difference (p. 59).

Maintenance and precautions

Usable cassette tapes

Your camcorder is capable of recording in both HDV and DV formats. You can use mini DV format cassettes only. Use a cassette with the ^{Mini}DV mark. Your camcorder is not compatible with the Cassette Memory function.

What is the HDV format?

The HDV format is a video format developed to record and play back digital high definition (HD) video signals on a DV cassette.

Your camcorder adopts the Interlace mode with 1,080 effective scan lines of screen ruling (1080i, number of pixels 1,440 × 1,080 dots).

The video bit rate for recording is about 25 Mbps.

i.LINK is adopted for the digital interface, enabling a digital connection with an HDV compatible TV or computer.

Tips

- HDV signals are compressed in MPEG2 format, which is adopted in BS (broadcast satellite) digital, terrestrial digital HDTV broadcastings, in Blu-ray Disc recorders, etc.

Playback

Your camcorder can play back pictures in both the DV format and HDV1080i specification.

Your camcorder can play back pictures recorded in the HDV 720/30p format, but cannot output it from the  HDV/DV Interface (i.LINK).

To prevent a blank section from being created on the tape

Go to the end of the recorded section using END SEARCH (p. 30) before you begin the next recording when you have played back the tape.

Copyright signal

■ When you play back

If the cassette you play back on your camcorder contains copyright signals, you cannot copy it to a tape in another video camera connected to your camcorder.

■ When you record

You cannot record software on your camcorder that contains copyright control signals for copyright protection of software. [Cannot record due to copyright protection.] appears on the LCD screen, or on the viewfinder if you try to record such software. Your camcorder does not record copyright control signals on the tape when it records.

Notes on use

■ When not using your camcorder for a long time

Remove the cassette and store it.

■ To prevent accidental erasure

Slide the write-protect tab on the cassette to set it to SAVE.

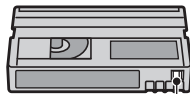

REC: The cassette can be recorded.

SAVE: The cassette cannot be recorded (write-protected).



Maintenance and precautions (Continued)

■ When labeling the cassette

Be sure to place the label only on the locations shown in the following illustration so as not to cause a malfunction of your camcorder.

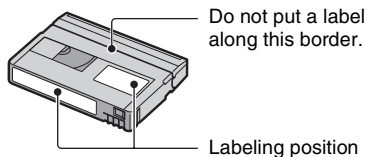

■ After using the cassette

Rewind the tape to the beginning to avoid distortion of the picture or the sound. The cassette should then be put in its case, and stored in an upright position.

■ When cleaning the gold-plated connector

Generally, clean the gold-plated connector on a cassette with a cotton-wool swab after every 10 times it has been ejected. If the gold-plated connector on the cassette is dirty or dusty, the remaining tape indicator may not show correctly.

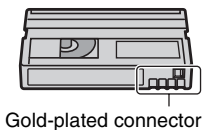

About the "Memory Stick"

A "Memory Stick" is a compact, portable IC recording medium with a large data capacity.

You can use the following types of "Memory Stick" listed below on the camcorder. However, we do not guarantee the operation of all types of "Memory Stick" on your camcorder. (See the list below for more details.)

Types of "Memory Stick"	Recording/ Playback
"Memory Stick Duo" (with MagicGate)	○
"Memory Stick PRO Duo"	○
"Memory Stick PRO-HG Duo"	○*

- * This camcorder does not support 8-bit parallel data transfer, but supports 4-bit parallel data transfer as is the case with "Memory Stick PRO Duo".
- This product cannot record or play data that uses "MagicGate" technology. "MagicGate" is a copyright protection technology that records and transfers the contents in an encrypted format.
- This product is compatible with "Memory Stick Micro" ("M2"). "M2" is the abbreviation for the "Memory Stick Micro."
- Still image format: Your camcorder compresses and records image data in the JPEG (Joint Photographic Experts Group) format. The file extension is ".JPG."
- File names of still images:
 - 101-0001: This file name appears on the screen of your camcorder.
 - DSC00001.JPG: This file name appears on the display of a computer.
- A "Memory Stick Duo" formatted by a computer (Windows OS/Mac OS) does not have guaranteed compatibility with your camcorder.
- Data read/write speed may vary depending on the combination of the "Memory Stick Duo" and "Memory Stick Duo" compliant product you use.
- You can prevent accidental erasure of images when you slide the write-protect tab on the "Memory Stick Duo" with a small tapered object, to the write-protect position.
- Damaged or lost image data will not be compensated for, and may occur in the following cases:
 - If you eject the "Memory Stick Duo," turn the power off on your camcorder, or remove the battery pack for replacement while your camcorder is reading or writing image files on the "Memory Stick Duo" (while the access lamp is lit or flashing).
 - If you use the "Memory Stick Duo" near magnets or magnetic fields.
- It is recommended to make a back-up of important data on the hard disk of a computer.

- Be careful not to apply excessive force when writing on a memo area on a “Memory Stick Duo.”
- Do not attach a label or the like on a “Memory Stick Duo” or a Memory Stick Duo adaptor.
- When you carry or store a “Memory Stick Duo,” put it in its case.
- Do not touch, or allow metallic objects to come into contact with the terminals.
- Do not bend, drop or apply strong force to the “Memory Stick Duo.”
- Do not disassemble or modify the “Memory Stick Duo.”
- Do not let the “Memory Stick Duo” get wet.
- Be careful to keep “Memory Stick Duo” media out of the reach of small children. There is danger that a child might swallow it.
- Do not insert anything other than a “Memory Stick Duo” into the Memory Stick Duo slot. Doing so may cause a malfunction.
- Do not use or keep the “Memory Stick Duo” in the following locations:
 - Places subject to extremely high temperature, such as a car parked outside in the summer.
 - Places under direct sunlight.
 - Places with extremely high humidity or subject to corrosive gases.

■ On the Memory Stick Duo adaptor

- When using a “Memory Stick Duo” with a “Memory Stick” compliant device, make sure to insert the “Memory Stick Duo” into a Memory Stick Duo adaptor.
- When inserting a “Memory Stick Duo” into a Memory Stick Duo adaptor, make sure the “Memory Stick Duo” is inserted facing in the correct direction, then insert it all the way in. Note that improper use may cause a malfunction. Also, if you force the “Memory Stick Duo” into the Memory Stick Duo adaptor in the wrong direction, it may be damaged.
- Do not insert a Memory Stick Duo adaptor without a “Memory Stick Duo” attached. Doing so may result in malfunctions of the unit.

■ On a “Memory Stick PRO Duo”

- The maximum memory capacity of a “Memory Stick PRO Duo” that can be used on your camcorder is 8 GB.

Notes on using “Memory Stick Micro”

- To use a “Memory Stick Micro” with the camcorder, you need a Duo-sized M2 Adaptor. Insert the “Memory Stick Micro” into the Duo-sized M2 Adaptor, then insert the adaptor into the Memory Stick Duo slot. If you insert a “Memory Stick Micro” into the camcorder without using a Duo-sized M2 Adaptor, you might not be able to remove it from the camcorder.
- Do not leave the “Memory Stick Micro” within the reach of small children. They might accidentally swallow it.

On image data compatibility

- Image data files recorded on a “Memory Stick Duo” by your camcorder conform to the “Design rule for Camera File system” universal standard established by the JEITA (Japan Electronics and Information Technology Industries Association).
- On your camcorder, you cannot play back still images recorded on other devices (DCR-TRV900E or DSC-D700/D770) that do not conform to the universal standard. (These models are not sold in some regions.)
- If you cannot use a “Memory Stick Duo” that has been used with another device, format it with your camcorder (p. 64). Note that formatting erases all information on the “Memory Stick Duo.”
- You may not be able to play back images with your camcorder:
 - When playing back image data modified on your computer.
 - When playing back image data recorded with other devices.

About the “InfoLITHIUM” battery pack

This unit is compatible with an “InfoLITHIUM” battery pack (L series). Your camcorder operates only with an “InfoLITHIUM” battery pack. “InfoLITHIUM” L series battery packs have the  mark.

What is an “InfoLITHIUM” battery pack?

An “InfoLITHIUM” battery pack is a lithium-ion battery pack that has functions for communicating information related to operating conditions between your camcorder and an optional AC Adaptor/charger.

The “InfoLITHIUM” battery pack calculates the power consumption according to the operating conditions of your camcorder, and displays the remaining battery time in minutes.

With an AC Adaptor/charger, the remaining battery time and charging time appear.

To charge the battery pack

- Be sure to charge the battery pack before you start using your camcorder.
- We recommend charging the battery pack in an ambient temperature of between 10 °C to 30 °C (50 °F to 86 °F) until the CHG (charge) lamp turns off. If you charge the battery pack outside of this temperature range, you may not be able to charge it efficiently.
- After charging is complete, disconnect the cable from the DC IN jack on your camcorder or remove the battery pack.

To use the battery pack effectively

- Battery pack performance decreases when the surrounding temperature is 10 °C (50 °F) or below, and the length of time you can use the battery pack becomes shorter. In that case, do one of the following to use the battery pack for a longer time.
 - Put the battery pack in a pocket to warm it up, and insert it in your camcorder right before you start taking shots.

- Use a large capacity battery pack: NP-F770/ NP-F970 (optional).

- Frequent use of the LCD screen or a frequent playback, fast forward or rewind operation wears out the battery pack faster. We recommend using a large capacity battery pack: NP-F770/NP-F970 (optional).
- Be sure to set the POWER switch to OFF (CHG) when not recording or playing back on your camcorder. The battery pack is also consumed when your camcorder is in recording standby or playback pause.
- Have spare battery packs ready for two or three times the expected recording time, and make trial recordings before making the actual recording.
- Do not expose the battery pack to water. The battery pack is not water resistant.

About the remaining battery time indicator

- When the power goes off even though the remaining battery time indicator indicates that the battery pack has enough power to operate, charge the battery pack fully again. Remaining battery time will be indicated correctly. Note, however, that the battery indication will not be restored if it is used in high temperatures for a long time, or if left in a fully charged state, or when the battery pack is frequently used. Use the remaining battery time indication as a rough guide only.
- The  mark that indicates low battery flashes even if there are still 5 to 10 minutes of battery time remaining, depending on the operating conditions or ambient temperature.

About storage of the battery pack

- If the battery pack is not used for a long time, fully charge the battery pack and use it up on your camcorder once a year to maintain proper function. To store the battery pack, remove it from your camcorder and put it in a dry, cool place.

About battery life

- Battery capacity decreases over time and through repeated use. If decreased usage time between charges becomes significant, it is probably time to replace it with a new one.

- Each battery's life is governed by storage, operating and environmental conditions.

About i.LINK

The HDV/DV Interface on this unit is an i.LINK-compliant Interface. This section describes the i.LINK standard and its features.

What is i.LINK?

i.LINK is a digital serial interface for transferring digital video, digital audio, and other data to other i.LINK-compatible devices. You can also control other devices using the i.LINK.

i.LINK-compatible devices can be connected using an i.LINK cable. Possible applications are operations and data transactions with various digital AV devices.

When two or more i.LINK-compatible devices are daisy-chained with the unit, operation becomes possible from any device in the chain. Note that operation method may vary, or data transactions may not be possible, depending on specifications and characteristics of the connected devices.

Notes

- Normally, only one device can be connected to this unit with an i.LINK cable. When connecting this unit to an HDV/DV compatible device having two or more i.LINK HDV/DV Interfaces, refer to the operating instructions of the device to be connected.

Tips

- i.LINK is a more familiar term for the IEEE1394 data transport bus proposed by Sony, and is a trademark approved by many corporations.
- IEEE1394 is an international standard standardized by the Institute of Electrical and Electronics Engineers.

About the i.LINK Baud rate

i.LINK's maximum baud rate varies according to the device. There are 3 types.

S100 (approx. 100 Mbps*)

S200 (approx. 200 Mbps)

S400 (approx. 400 Mbps)

The baud rate is listed under "Specifications" in the operating instructions of each piece of equipment. It is also indicated near the i.LINK interface on some devices.

The baud rate may differ from the indicated value when the unit is connected to a device with a different maximum baud rate.

* What is Mbps?

Mbps stands for "megabits per second," or the amount of data that can be sent or received in one second. For example, a baud rate of 100 Mbps means that 100 megabits of data can be sent in one second.

To use i.LINK functions on this unit

For details on how to dub when this unit is connected to other video devices having an i.LINK Interface, see page 62.

This unit can also be connected to other i.LINK-compatible devices made by Sony (e.g. a VAIO series personal computer) as well as to video devices.

Some i.LINK compatible video devices, such as Digital Televisions, DVD, MICROMV or HDV recorders/players are not compatible with this unit. Before connecting to other devices, be sure to confirm whether the device is compatible with an HDV/DV device or not. For details on precautions and compatible application software, refer also to the operating instructions for the device to be connected.

Maintenance and precautions (Continued)

🔊 Notes

- When connecting your camcorder to another i.LINK-compatible device, be sure to turn off the power of the device and disconnect the AC Adaptor from the wall outlet (wall socket) before connecting or disconnecting the i.LINK cable.

About the required i.LINK cable

Use the Sony i.LINK 4-pin-to-4-pin cable (during HDV/DV dubbing).

About x.v.Color

- x.v.Color is a more familiar term for the xvYCC standard proposed by Sony, and is a trademark of Sony.
- xvYCC is an international standard for color space in video. This standard can express a wider color range than the currently used broadcast standard.

On using your camcorder

On use and care



- Do not use or store the camcorder and accessories in the following locations.
 - Anywhere extremely hot or cold. Never leave them exposed to temperatures above 60 °C (140 °F), such as under direct sunlight, near heaters or in a car parked in the sun. They may malfunction or become deformed.
 - Near strong magnetic fields or mechanical vibration. The camcorder may malfunction.
 - Near strong radio waves or radiation. The camcorder may not be able to record properly.
 - Near AM receivers and video equipment. Noise may occur.
 - On a sandy beach or anywhere dusty. If sand or dust gets in your camcorder, it may malfunction. Sometimes this malfunction cannot be repaired.
 - Near windows or outdoors, where the LCD screen, the viewfinder, or the lens may be exposed to direct sunlight. This damages the inside of the viewfinder or the LCD screen.
 - Anywhere very humid.
- Operate your camcorder on DC 6.8 V (battery pack) or DC 8.4 V (AC Adaptor).

- For DC or AC operation, use the accessories recommended in these operating instructions.
- Do not let your camcorder get wet, for example, from rain or sea water. If your camcorder gets wet, it may malfunction. Sometimes this malfunction cannot be repaired.
- If any solid object or liquid gets inside the casing, unplug your camcorder and have it checked by a Sony dealer before operating it any further.
- Avoid rough handling, disassembling, modifying, physical shock, or impact such as hammering, dropping or stepping on the product. Be particularly careful of the lens.
- Keep the POWER switch setting to OFF (CHG) when you are not using your camcorder.
- Do not wrap your camcorder with a towel, for example, and operate it. Doing so might cause heat to build up inside.
- When disconnecting the power cord (mains lead), pull it by the plug and not the cord (lead).
- Do not damage the power cord (mains lead) such as by placing anything heavy on it.
- Keep metal contacts clean.
- If the battery electrolytic liquid has leaked,
 - consult your local authorized Sony service facility.
 - wash off any liquid that may have contacted your skin.
 - if any liquid gets in your eyes, wash with plenty of water and consult a doctor.

■ When not using your camcorder for a long time



- Periodically turn on the camcorder and play a cassette for about 3 minutes.
- Use up the battery pack completely before storing it.

Moisture condensation

If your camcorder is brought directly from a cold place to a warm place, moisture may condense inside your camcorder, on the surface of the tape, or on the lens. In this state, the tape may stick to the head drum and be damaged or your camcorder may not operate correctly. If there is moisture inside your camcorder, [▲ Moisture condensation. Eject the cassette] or [] Moisture condensation. Turn off for 1H.] appears. The indicator will not appear when the moisture condenses on the lens.

■ If moisture condensation has occurred

None of the functions except cassette ejection will work. Eject the cassette, turn off your camcorder, and leave it for about one hour with the cassette lid open. Your camcorder can be used again when both of the following conditions are met:

- The warning message does not appear when the power is turned on.
- Neither  or  flash when a cassette is inserted and video operation buttons are touched.

If moisture starts to condense, your camcorder sometimes cannot detect condensation. If this happens, the cassette is sometimes not ejected for 10 seconds after the cassette lid is opened. This is not a malfunction. Do not close the cassette lid until the cassette is ejected.

■ Note on moisture condensation

Moisture may condense when you bring your camcorder from a cold place into a warm place (or vice versa) or when you use your camcorder in a humid place as shown below.

- When you bring your camcorder from a ski slope into a place warmed up by a heating device.
- When you bring your camcorder from an air conditioned car or room into a hot place outside.
- When you use your camcorder after a squall or a shower.
- When you use your camcorder in a hot and humid place.

■ How to avoid moisture condensation

When you bring your camcorder from a cold place into a warm place, put your camcorder in a plastic bag and seal it tightly. Remove the bag when the air temperature inside the plastic bag has reached the surrounding temperature (after about one hour).

Video head

If you play back a tape recorded in HDV format, the image and sound may freeze for a while (about 0.5 seconds).

This occurs if the HDV signals cannot be recorded or played back correctly because of dirt on the tape or video head. Depending on the cassette, this fairly infrequently occurs even if the cassette is brand new or is not used a lot.

If this freezing point is created while playing back, you can solve this problem and see the pictures by rewinding after slightly forwarding. Such a freezing point cannot be recovered if it was created while recording.

To prevent such a problem, use the Sony mini DV cassette.

- If the following problem occurs, clean the video heads for 10 seconds with the cleaning cassette.
 - Playback pictures do not move.
 - Playback pictures do not appear.
 - The sound breaks off.
 - [] Dirty video head. Use a cleaning cassette.] appears on the screen during recording.
 - The following phenomenon occurs in HDV format.



The playback screen pauses.



The playback screen goes blank. (Solid blue screen)

Maintenance and precautions (Continued)

- The following phenomenon occurs in DV format.



Block-noise appears.



The playback screen goes blank.
(Solid blue screen)

- The video heads will degrade after long use. If you cannot obtain a clear image even after using a cleaning cassette (optional), it might be because the video heads are worn out. Please contact your Sony dealer or local authorized Sony service facility to have the video heads replaced.

LCD screen

- Do not exert excessive pressure on the LCD screen, as it may cause damage.
- If your camcorder is used in a cold place, a residual image may appear on the LCD screen. This is not a malfunction.
- While using your camcorder, the back of the LCD screen may heat up. This is not a malfunction.

■ To clean the LCD screen

If fingerprints or dust make the LCD screen dirty, it is recommended you use a soft cloth to clean it. When you use the LCD Cleaning Kit (optional), do not apply the cleaning liquid directly to the LCD screen. Use cleaning paper moistened with the liquid.

■ On adjustment of the touch panel (CALIBRATION)

The buttons on the touch panel may not work correctly. If this happens, follow the procedure below. It is recommended you connect your camcorder to the wall outlet (wall socket) using the supplied AC Adaptor during the operation.

- ① Slide the POWER switch to PLAY/EDIT.

- ② Touch [P-MENU] → [MENU] →  (STANDARD SET) → [CALIBRATION] → [OK].

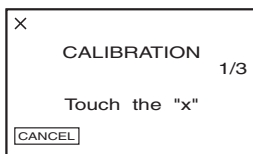

- ③ Touch the “x” displayed on the screen with the corner of the “Memory Stick Duo” or the like.

The position of the “x” changes.

To cancel, touch [CANCEL].

If you did not press the right spot, start from step ③ again.

⚡ Notes

- You cannot calibrate the LCD screen if it is rotated.

On handling the casing

- If the casing is soiled, clean the camcorder body with a soft cloth lightly moistened with water, and then wipe the casing with a dry soft cloth.
- Avoid the following to avoid damage to the finish.
 - Using chemicals such as thinner, benzene, alcohol, chemical cloths, repellent, insecticide and sunscreen.
 - Handling with above substances on your hands.
 - Leaving the casing in contact with rubber or vinyl objects for a long period of time.

About care and storage of the lens

- Wipe the surface of the lens clean with a soft cloth in the following instances:
 - When there are fingerprints on the lens surface.
 - In hot or humid locations
 - When the lens is exposed to salty air such as at the seaside.
- Store in a well-ventilated location subject to little dirt or dust.

- To prevent mold, periodically clean the lens as described above. It is recommended that you operate your camcorder about once a month to keep it in optimum state for a long time.

On charging the pre-installed rechargeable battery

Your camcorder has a pre-installed rechargeable battery to retain the date, time, and other settings even when the POWER switch is set to OFF (CHG). The pre-installed rechargeable battery is always charged while your camcorder is connected to the wall outlet (wall socket) via the AC Adaptor or while the battery pack is inserted. The rechargeable battery will be fully discharged in about **3 months** if you do not use your camcorder at all without the AC Adaptor connected or the battery pack attached. Use your camcorder after charging the pre-installed rechargeable battery.

However, even if the pre-installed rechargeable battery is not charged, the camcorder operation will not be affected as long as you are not recording the date.

■ Procedures

Connect your camcorder to a wall outlet (wall socket) using the supplied AC Adaptor, and leave it with the POWER switch set to OFF (CHG) for more than 24 hours.

Removing dust from inside the viewfinder

1 Remove the viewfinder.

While sliding the viewfinder release lever downward ①, turn the viewfinder counterclockwise until the **I** markings on the left side are aligned ②, then remove the viewfinder upward ③.

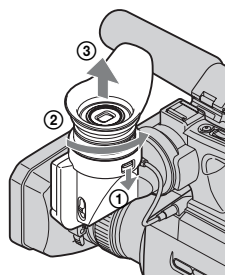

2 Remove dust from inside the viewfinder and the part shown below with a blower.

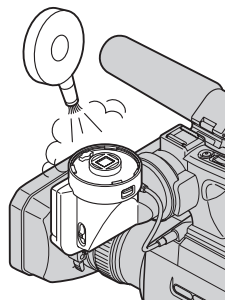

3 Follow the reverse procedure of step 1. 1. Align the **I** markings on the left side and attach the viewfinder by pressing it downward lightly. Then turn it clockwise until it is clicked.

Specifications

System

Video recording system (HDV)

2 rotary heads, Helical scanning system

Video recording system (DV)

2 rotary heads, Helical scanning system

Still image recording system

Exif Ver. 2.2*¹

Audio recording system (HDV)

Rotary heads, MPEG-1 Audio Layer -2,

Quantization: 16 bits (Fs 48 kHz, stereo)

transfer rate: 384 kbps

Audio recording system (DV)

Rotary heads, PCM system

Quantization: 12 bits (Fs 32 kHz, stereo 1, stereo 2), 16 bits (Fs 48 kHz, stereo)

Video signal

NTSC color, EIA standards

1080/60i specification

Usable cassette

Mini DV cassette with the ^{Mini} **DV** mark printed

Tape speed (HDV)

Approx. 18.81 mm/s

Tape speed (DV)

SP: Approx. 18.81 mm/s

LP: Approx. 12.56 mm/s

Recording/playback time (HDV)

60 min (using a DVM60 cassette)

Recording/playback time (DV)

SP: 60 min (using a DVM60 cassette)

LP: 90 min (using a DVM60 cassette)

Fast forward/rewind time

Approx. 2 min 40 s (using a DVM60 cassette and rechargeable battery pack)

Approx. 1 min 45 s (using a DVM60 cassette and AC Adaptor)

Viewfinder

Electric viewfinder (color)

Image device

6.3 mm (1/2.9 type) CMOS sensor

Recording pixels (still, 4:3):

Max. 6.1 mega (2 848 × 2 136) pixels*²

Gross: Approx. 3 200 000 pixels

Effective (movie, 16:9):

Approx. 2 280 000 pixels

Effective (movie, 4:3):

Approx. 1 710 000 pixels

Effective (still, 16:9):

Approx. 2 280 000 pixels

Effective (still, 4:3):

Approx. 3 040 000 pixels

Lens

Carl Zeiss Vario-Sonnar T*

10 × (Optical), 20 × (Digital)

Focal length

f=5.4 ~ 54 mm (7/32 ~ 2 1/4 in.)

When converted to a 35 mm still camera

In TAPE: 40 ~ 400 mm (1 5/8 ~ 15 3/4 in.) (16:9), 49 ~ 490 mm (1 15/16 ~ 19 3/8 in.) (4:3)

In MEMORY: 40 ~ 400 mm (1 5/8 ~ 15 3/4 in.) (16:9), 37 ~ 370 mm (1 1/2 ~ 14 5/8 in.) (4:3)

F1.8 ~ 2.9

Filter diameter: 37 mm (1 1/2 in.)

Color temperature

[AUTO], [ONE PUSH], [INDOOR] (3 200 K),

[OUTDOOR] (5 800 K)

Minimum illumination

5 lx (lux) ([AUTOSLW SHTR] [ON], Shutter speed 1/30 sec)

0 lx (lux) (during NightShot function)

*¹“Exif” is a file format for still images, established by the JEITA (Japan Electronics and Information Technology Industries Association). Files in this format can have additional information such as your camcorder’s setting information at the time of recording.

*2The unique pixel array of Sony's ClearVid CMOS sensor and image processing system (new Enhanced Imaging Processor) allows for still image resolution equivalent to the sizes described.

Input/Output connectors

VIDEO OUT jack

Pin jack
1 Vp-p, 75 Ω (ohms)

S VIDEO OUT jack

4pin mini DIN
Luminance signal: 1 Vp-p, 75 Ω (ohms)
Chrominance signal: 0.286 Vp-p, 75 Ω (ohms)

AUDIO OUT jack

Pin jack
Audio signal: 327 mV (at load impedance 47 k Ω (kilohms)), Output impedance with less than 2.2 k Ω (kilohms)

COMPONENT OUT jack

Y: 1 Vp-p, 75 Ω (ohms)
PB/PR, CB/CR: \pm 350 mV, 75 Ω (ohms)

HDMI OUT jack

Type A (19-pin)

Headphone jack

Stereo minijack (\varnothing 3.5 mm)

LANC jack

Stereo mini-minijack (\varnothing 2.5 mm)

USB jack

B

MIC (PLUG IN POWER) jack

Stereo minijack (\varnothing 3.5 mm)

i.LINK jack

i.LINK Interface (IEEE1394, 4-pin connector S100)

LCD screen

Picture

6.7 cm (2.7 type, aspect ratio 16:9)

Total dot number

211 200 (960 \times 220)

General

Power requirements

DC 7.2 V (battery pack)
DC 8.4 V (AC Adaptor)

Average power consumption

During camera recording using the viewfinder with normal brightness:
HDV recording 4.6 W
DV recording 4.4 W
During camera recording using the LCD & viewfinder with normal brightness:
HDV recording 5.0 W
DV recording 4.8 W

Operating temperature

0 $^{\circ}$ C to + 40 $^{\circ}$ C (32 $^{\circ}$ F to 104 $^{\circ}$ F)

Storage temperature

-20 $^{\circ}$ C to + 60 $^{\circ}$ C (-4 $^{\circ}$ F to + 140 $^{\circ}$ F)

Dimensions (approx.)

265 \times 231 \times 460 mm
(10 4/8 \times 9 1/8 \times 18 1/8 in.) (w/h/d) including the projecting parts
265 \times 231 \times 460 mm
(10 4/8 \times 9 1/8 \times 18 1/8 in.) (w/h/d) including the projecting parts with the supplied battery pack NP-F570 attached

Mass (approx.)

2.7 kg (6 lb 0 oz) main unit only
3.0 kg (6 lb 10 oz) including the NP-F570 rechargeable battery pack and cassette (PHDVM-63DM), and lens hood with lens cover, microphone.

Supplied accessories

See page 12.

AC Adaptor AC-L100

Power requirements

AC 100 V - 240 V, 50/60 Hz

Current consumption

0.35 - 0.18 A

Power consumption

18 W

Specifications (Continued)

Output voltage

DC 8.4 V*

Operating temperature

0 °C to + 40 °C (32 °F to 104 °F)

Storage temperature

-20 °C to + 60 °C (-4 °F to + 140 °F)

Dimensions (approx.)

48 × 29 × 81 mm (1 15/16 × 1 3/16 × 3 1/4 in.) (w/h/d) excluding the projecting parts

Mass (approx.)

170 g (6.0 oz) excluding the power cord (mains lead)

* See the label on the AC Adaptor for other specifications.

Rechargeable battery pack (NP-F570)

Maximum output voltage

DC 8.4 V

Output voltage

DC 7.2 V

Capacity

15.8 Wh (2 200 mAh)

Dimensions (approx.)

38.4 × 20.6 × 70.8 mm
(1 9/16 × 13/16 × 2 7/8 in.) (w/h/d)

Mass (approx.)

100 g (3.5 oz)

Operating temperature

0 °C to + 40 °C (32 °F to 104 °F)

Type

Lithium ion

Design and specifications are subject to change without notice.

On trademarks

- HDV and the HDV logo are trademarks of Sony Corporation and Victor Company of Japan, Ltd.
- “Memory Stick,”  “Memory Stick Duo,” “MEMORY STICK DUO,” “Memory Stick PRO Duo,” “MEMORY STICK PRO DUO,” “Memory Stick PRO-HG Duo,” “MEMORY STICK PRO-HG DUO,” “Memory Stick Micro,” “MagicGate,” “MAGIC GATE,” “MagicGate Memory Stick” and “MagicGate

Memory Stick Duo” are trademarks of Sony Corporation.

- “InfoLITHIUM” is a trademark of Sony Corporation.
- i.LINK and  are trademarks of Sony Corporation.
- Mini  is a trademark.
- “x.v.Color” is a trademark of Sony Corporation.
- Microsoft, Windows, and Windows Media, Windows Vista are trademarks or registered trademarks of U.S. Microsoft Corporation in the U.S. and other countries.
- Macintosh and Mac OS are trademarks of Apple Inc. in the U.S. and other countries.
- HDMI, the HDMI logo, and High-Definition Multimedia Interface are trademarks or registered trademarks of HDMI Licensing LLC.
- Intel, Intel Core and Pentium are either registered trademarks or trademarks of Intel Corporation and its subsidiaries in the United States and/or other countries.
- Adobe and Adobe Reader are either registered trademarks or trademarks of Adobe Systems Incorporated in the United States and/or other countries.

All other product names mentioned herein may be the trademarks or registered trademarks of their respective companies. Furthermore, “™” and “®” are not mentioned in each case in this manual.

Notes on the License

ANY USE OF THIS PRODUCT OTHER THAN CONSUMER PERSONAL USE IN ANY MANNER THAT COMPLIES WITH THE MPEG-2 STANDARD FOR ENCODING VIDEO INFORMATION FOR PACKAGED MEDIA IS EXPRESSLY PROHIBITED WITHOUT A LICENSE UNDER APPLICABLE PATENTS IN THE MPEG-2 PATENT PORTFOLIO, WHICH LICENSE IS AVAILABLE FROM MPEG LA, L.L.C., 250 STEELE STREET, SUITE 300, DENVER, COLORADO 80206.

Identifying parts and controls

The numbers in () are reference pages.

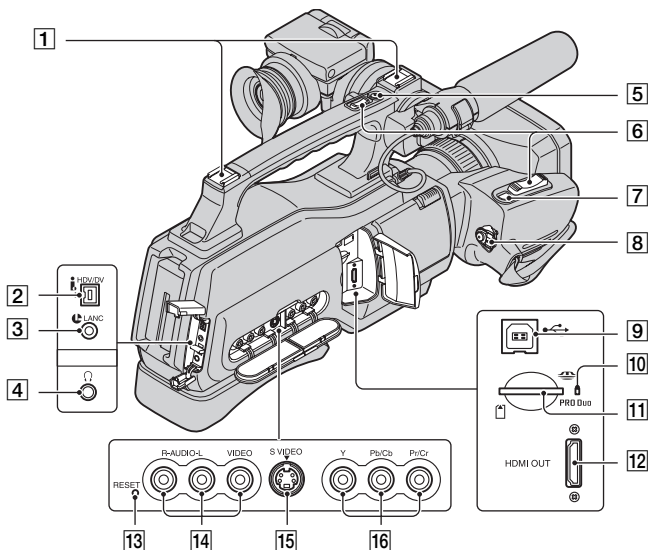

- 1** Cold shoe
- 2** HDV/DV Interface (i.LINK) (31, 63, 65)
- 3** LANC jack (blue)
The LANC control jack is used for controlling the tape transport of video devices and peripherals connected to it.
- 4** (Headphone) jack
- 5** REC START/STOP button (22)
- 6** Power zoom lever (24)
- 7** PHOTO button (23)
- 8** POWER switch (18)
- 9** (USB) jack (69)
- 10** Access lamp (20, 90)
- 11** “Memory Stick Duo” slot (20)
- 12** HDMI OUT jack (Output only) (31)
- The available video signals are read, and the appropriate output format is selected and output automatically.
 - You can check the setup value of HDMI OUTPUT on [STATUS CHECK] (p. 57).
- 13** RESET button
Initializes all the settings, including the setting of the date and time (Menu items customized on Personal Menu are not initialized).
- 14** A/V (audio/video) OUT jack (31, 63)
- 15** S VIDEO OUT jack (31)
- 16** COMPONENT OUT jack (31)

Identifying parts and controls (Continued)

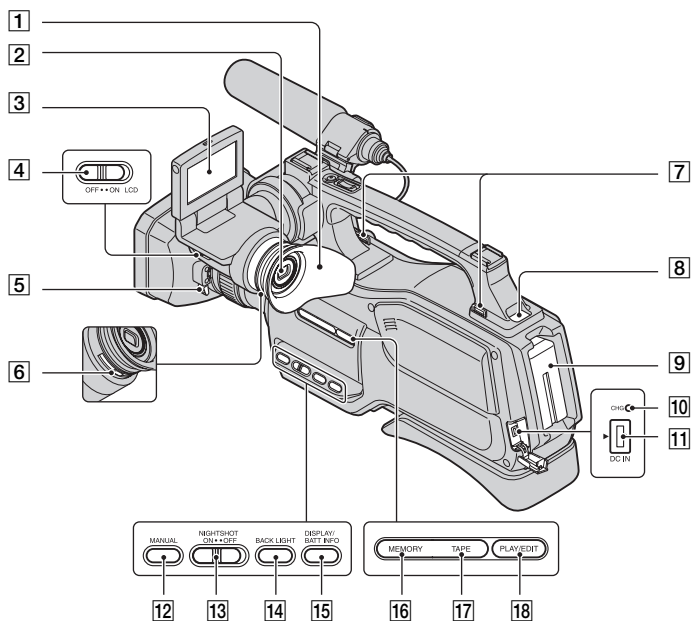

- | | |
|---|---|
| 1 Eyecup | 9 Battery pack (15) |
| 2 Viewfinder (19) | 10 CHG (charge) lamp (15) |
| 3 LCD screen/touch panel (7, 19) | 11 DC IN jack (15) |
| 4 LCD ON/OFF switch (19) | 12 MANUAL button (25) |
| 5 Lens hood release lever (14) | 13 NIGHTSHOT switch (25) |
| 6 Viewfinder lens adjustment lever (19) | 14 BACK LIGHT button (26) |
| 7 Hook for the Shoulder belt
Attach the Shoulder belt (optional). | 15 DISPLAY/BATT INFO button (19) |
| 8 BATT(battery) RELEASE button (16) | 16 MEMORY mode lamp (18) |
| | 17 TAPE mode lamp (18) |
| | 18 PLAY/EDIT mode lamp (18) |

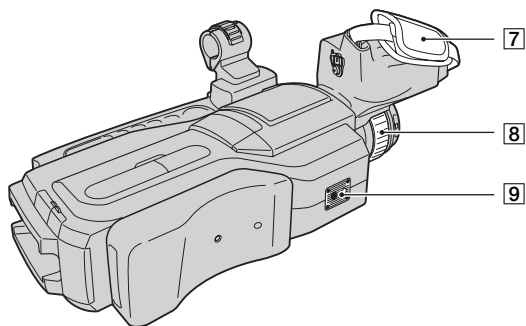
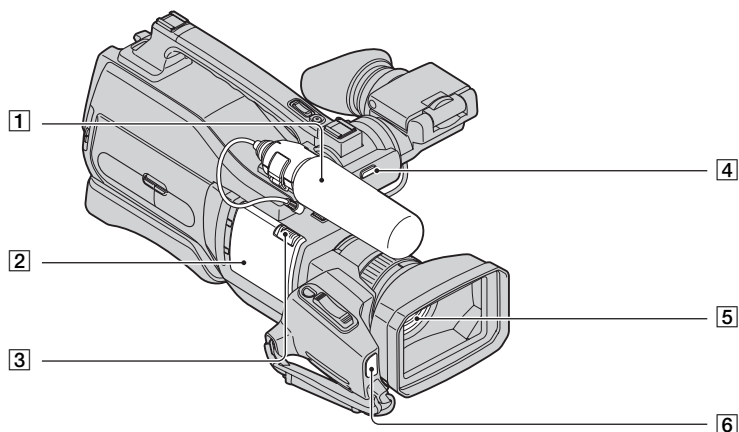

1 Microphone (13)

2 Cassette compartment lid (20)

3  OPEN/EJECT lever (20)

4 REC lamp (Camera recording lamp)

- The REC lamp lights up in red during recording (p. 58).
- The REC lamp flashes if the remaining tape or battery power is low.

5 Lens (Carl Zeiss Lens) (8)

6 Infrared port

7 Grip belt

8 RING (25)

9 Tripod receptacle

Attach the tripod (optional: the length of the screw must be less than 5.5 mm (7/32 in.)) to the tripod receptacle using a tripod screw.

Indicators displayed during recording/playback

Recording movies

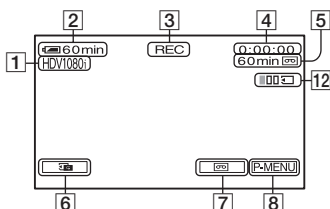

- 1 Recording format (HDV1080i or DV) (54)
Recording mode (SF or LP) is also displayed in the DV format.
- 2 Remaining battery (approx.)
- 3 Recording status ([STBY] (standby) or [REC] (recording))
- 4 During recording:
Tape counter (hour: minute: second)
During playback:
Time code (hour: minute: second: frame)
- 5 Recording capacity of the tape (approx.) (58)
- 6 Review button for still images on the “Memory Stick Duo” (23)
Appears when “Memory Stick Duo” is inserted.
- 7 END SEARCH/Rec review display switch button (30)
- 8 Personal Menu button (36)

Recording still images during tape recording (Dual Rec)

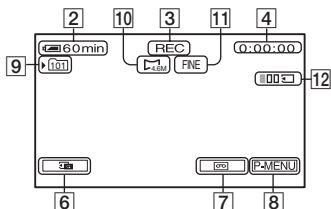

- 9 Recording folder (48)
- 10 Image size (46)
- 11 Quality ([FINE] or [STD]) (46)
- 12 Number of recorded still images (24)

Recording still images

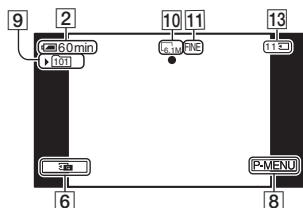

- 13 “Memory Stick Duo” indicator and the number of images that can be recorded (approx.)

Data code during recording

The date/time during recording and the camera setting data will be recorded automatically. They do not appear on the screen during recording, but you can check them as [DATA CODE] during playback (p. 58).

Viewing movies

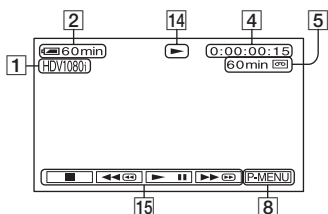

- 14 Tape transport indicator
- 15 Video operation buttons (27)

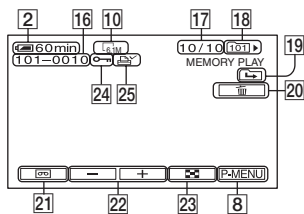

Viewing still images







- 16 Data file name
- 17 Picture number/Total number of recorded pictures in the current playback folder
- 18 Playback folder (48)

19 Previous/Next folder icon

The following indicators appear when the first or last picture of the current folder is displayed and when there are multiple folders on the same “Memory Stick Duo.”

 : Touch  to move to the previous folder.

 : Touch  to move to the next folder.

 : Touch  /  to move to either the previous or the next folder.

- 20 Image delete button (67)
- 21 Tape playback select button (28)
- 22 Previous/Next image button (28)
- 23 Index screen display button (28)
- 24 Image protection mark (68)
- 25 Print mark (68)

Indicators displayed during recording/playback (Continued)

Indicators when you made changes

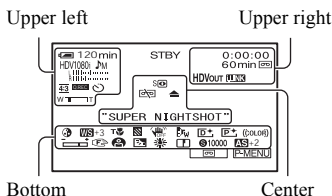

Upper left

Indicator	Meaning
HDV1080i DV	Recording format (54)
	Manual sound level adjustment (55)
J16b	AUDIO MODE* (54)
SP LP	Recording mode* (54)
	Self-timer recording (44)
4:3	WIDE SELECT* (54)
Q.REC	QUICK REC** (59)
	Interval photo recording (49)

Upper right

Indicator	Meaning
HDV IN DV IN	HDV input/ DV input (65)
HDV out DV out	HDV output/ DV output (31, 64)
i.LINK	i.LINK connection (31, 64, 65)
	Slide show (49)

Center

Indicator	Meaning
	Color Slow Shutter (43)
	PictBridge connecting (69)
	Warning (85)
	NightShot (25)
SN	Super NightShot (43)

Bottom

Indicator	Meaning
AS	AE SHIFT (41)
WS	WB SHIFT (42)
P+	Picture effect (51)
D+	Digital effect (50)
	Manual focus (42)
	SCENE SELECT (39)
	Sharpness (41)
	Backlight (26)
	White balance (40)
	SteadyShot off (44)
	Zebra (44)
T	Tele macro (43)
	CAMERA COLOR (42)
D _W D _T	CONV.LENS (45)
(COLOR)	X.V.COLOR** (45)
	SPOT METER (40)/ EXPOSURE (40)
S	SHUTTR SPEED (41)
	ZOOM by RING SETTING(25)

* The settings can be made only for the pictures in the DV format.

**The setting can be made only for the pictures in the HDV format.

Notes

- Indicators and their positions are approximate and differ from what you actually see.

Other indicator

Indicator	Meaning
	Information (86)

Index

Numeric

1080i/480i.....	56
12BIT.....	54
16BIT.....	54
480i.....	56

A

AC Adaptor.....	15
AE SHIFT.....	41, 83
ALL ERASE.....	47
AUDIO MIX.....	54
AUDIO MODE.....	54
AUTOSLW SHTR (Auto slow shutter).....	41
AU.LVL DISP (Audio level display).....	55
A/V connecting cable.....	32, 62
A/V OUT jack.....	31

B

BACK LIGHT.....	26
Battery.....	15
BEACH.....	39
BEEP.....	58

C

CALIBRATION.....	96
CAMERA COLOR.....	42
CAMERA DATA.....	58
CAMERA SET menu.....	39
CANDLE.....	39
Cassette.....	20, 89
Charging time.....	16
Cleaning cassette.....	95
CLOCK SET.....	18
COLOR BAR.....	57
COLOR SLOW S (Color Slow Shutter).....	43, 80, 83
COMPONENT.....	56
COMPONENT OUT jack.....	31
Component video cable.....	32

Computer.....	71
CONV.LENS.....	45

D

DATA CODE.....	18, 58
DATE/TIME.....	58, 104
Delete pictures.....	67
DIGITAL ZOOM.....	44, 83
DISP OUTPUT (Display output).....	58
Display indicators.....	104
DOWN CONVERT.....	56
Dual Rec.....	24
Dubbing.....	62
DV format.....	53
DV SET.....	54
D.EFFECT (Digital effect).....	50, 83

E

EDIT/PLAY menu.....	52
END SEARCH.....	30, 53
EXPOSURE.....	40, 83

F

FADER.....	49, 83
FILE NO. (File number).....	47
FIREWORKS.....	39
FLASH (Flash motion).....	50
FOCUS.....	42, 80
FORMAT.....	47
Frame-by-frame Playback.....	52

G

Getting Started.....	12
GUIDEFAME.....	57

H

HD (high definition) image quality.....	32
HDMI cable.....	33

HDMI OUT jack.....	31
HDV format.....	53
HDV1080i.....	54
HDV/DV Interface.....	31
HISTOGRAM.....	44

I

Image protection.....	68
Image size (IMAGE SIZE) ..	46
INDOOR.....	40
“InfoLITHIUM” battery pack.....	92
INT.REC-STL (Interval photo recording).....	49
i.LINK.....	93
i.LINK cable.....	33, 63, 66
i.LINK CONV.....	56

L

LANDSCAPE.....	39
LANGUAGE.....	59
LCD BL LEVEL (LCD back light level).....	55
LCD BRIGHT.....	55
LCD COLOR.....	55
LCD/VF SET.....	55
LP (Long Play).....	54

M

Macintosh.....	74
Maintenance and precautions.....	89
MEMORY SET menu.....	46
“Memory Stick”.....	90
“Memory Stick Duo”.....	20
FORMAT.....	47
Menu.....	36
MIC LEVEL.....	55
Mirror mode.....	26
Moisture condensation.....	95
MONOTONE.....	49
MOSAIC FADER.....	49

N

NEG.ART	51
NEW FOLDER.....	48
NS LIGHT (NightShot Light)	43
NTSC	81, 88
Number of recordable pictures.....	46

O

OLD MOVIE.....	50
ONE PUSH.....	40
OUTDOOR.....	40

P

PAL.....	88
PASTEL.....	51
PB FOLDER (Playback folder)	48
PB zoom.....	29
Personal Menu.....	36, 60
PICT.APPLI. menu (Picture Application menu)....	49
PICT.EFFECT (Picture effect)	51
Playback.....	27
Playing time.....	17
P-MENU.....See Personal Menu	
PORTRAIT (Soft portrait)....	39
Power cord (Mains lead).....	15
Print	69
Print mark	68

Q

QUALITY.....	46
QUICK REC (Quick recording).....	59

R

REC CTRL (Recording control).....	65
--------------------------------------	----

REC FOLDER (Recording folder).....	48
REC MODE (Recording mode)	54
Rec review.....	30
Recording.....	22
Recording time.....	16
REMAINING.....	58
Remaining battery	16, 104
Reversal Playback.....	52
RING.....	25
RING SETTING	45

S

S VIDEO jack	31, 33, 62
SCENE SELECT	39, 83
SD (standard definition) image quality	33
Searching for the starting point	30
SELF-TIMER.....	44
SEPIA.....	51
SHARPNESS	41, 83
SHUTTR SPEED.....	41
SKINTONE.....	51
SLIDE SHOW.....	49
SMTH SLW REC (Smooth slow recording)	51, 84
SNOW	39
SOLARIZE	51
SP (Standard Play)	54
Specifications	98
SPOT FOCUS	42, 83
SPOT METER (Flexible spot meter).....	40, 83
SPOTLIGHT	39
STANDARD.....	46
STANDARD SET menu.....	53
STATUS CHECK.....	57
STEADYSHOT	44, 80
STILL.....	50
Still image	23, 28, 46

STILL SET.....	46
SUNRSE SUNSET (Sunrise and sunset).....	39
SUPER NS (Super NightShot).....	43

T

Tape counter	104
TELE MACRO.....	43, 83
Time code	104
TIME/LANGU. menu	59
TRAIL	50
TV.....	31
TV color systems.....	88
TWILIGHT.....	39

U

USB SELECT.....	52
Using abroad.....	88

V

VAR.SPD PB (Various speed playback).....	52
VCR HDV/DV	53
VF B.LIGHT (Viewfinder brightness).....	56
VF COLOR	56
VIDEO OUT	56
VOLUME	55

W

Warning indicators	85
Warning messages.....	86
WB SHIFT (White Balance Shift).....	42
WHITE BAL. (White balance)	40, 83
WHITE FADER	49
Windows.....	71, 72
WORLD TIME.....	59
Write-protect tab.....	89

Index (Continued)

X

X.V.COLOR.....45, 94

Z

ZEBRA.....44

Zoom.....24

SONY

Digital HD Video Camera Recorder

US

<http://www.sony.net/>



Printed on 70% or more recycled paper
using VOC (Volatile Organic Compound)
-free vegetable oil based ink.

Printed in Japan



3278988120